

# THE X7



BAYERISCHE MOTOREN WERKE







# 1

## THE FIRST BMW X7.



# 2

## DESIGN AND HIGHLIGHTS

- 30 The Vision
- 32 Exterior design
- 34 Interior design
- 36 Sense of space
- 40 Driving comfort

# 3

## INNOVATION AND TECHNOLOGY

- The Vision 42
- Driver assistance 44
- Connectivity and infotainment 46
- Comfort and functionality 48



# 4

## EQUIPMENT

- 50 The Vision
- 52 BMW Individual
- 56 Exterior colour world
- 58 Interior colour world
- 62 Technical values



## DIGITAL DISCOVERY: THE NEW BMW BROCHURES APP.



More information, more driving pleasure: The new BMW brochures app offers you a brand new digital and interactive BMW experience. Download the BMW brochures app for your smartphone or tablet now and explore new perspectives of your BMW.



Let's talk about courage,  
and why we need it more than ever.

Courage is independent and disruptive.  
Courage questions, shatters and awakens.

We need bold, courageous voices.  
All of us.

We need fresh thinkers with optimism.  
Daring dreamers who don't accept  
"No" for an answer.

We believe in the frontrunners.  
The intellectual elite, the avantgarde.  
Those who fight stagnation and backwardness.

Well, courage only knows forward.  
Driving the pioneers of our culture  
to inspire tomorrow.  
To create a sublime kind of new.  
Reaching a superior level of excellence.

This is where  
a new kind of luxury is born,  
in brave ideas, in the confidence  
to speak out loud.  
Even if nobody asks for it.



BAYERISCHE MOTOREN WERKE





WHEN SIZE GETS SPACE,  
UNIQUE THINGS CAN ARISE.





IF CURIOSITY MEETS EXPERIENCE AND AMBITION  
MEETS PERFECTION, AN INSIGHT IS REFLECTED:  
PRESENCE IS A MATTER OF APPEAL.



AT THE END OF THE DAY, THE THINGS THAT BELONG TOGETHER ALWAYS FIND EACH OTHER. PRESENCE MEETS CHARISMA AND DYNAMISM. THE RESULT IS TRUE GREATNESS.







SOMETIMES YOU HAVE TO CHANGE PERSPECTIVE  
TO REALISE: PERSONALITY SURPASSES EVERYTHING.





SPATIAL THINKING IS A SKILL. TO SEE A SPACE AS A LIVING SPACE, AN ART. TO TAKE TO THIS SPACE, REAL FREEDOM.









THERE ARE PLACES THAT MAGICALLY ATTRACT US AND ONCE WE ARRIVE THERE, WE DON'T WANT TO LEAVE ANYMORE. UNLESS THE REASON TO DO IT ANYWAY IS RIGHT IN FRONT OF US.





SOMETIMES YOU WANT TO CREATE SOMETHING  
EXTRAORDINARY, SOMETIMES YOU WANT TO  
EXPERIENCE SOMETHING EXTRAORDINARY. IN ANY CASE,  
THE MOMENT BECOMES SOMETHING SPECIAL.





YOU DON'T REMEMBER THE ORDINARY.  
UNIQUE THINGS FASCINATE YOU EVEN AT  
THE THOUSANDTH ENCOUNTER.









UP THERE. PHENOMENAL. IMPRESSIVE. SOMETIMES SIZE HAS SOMETHING TO DO WITH GREATNESS.



CHARACTER STRENGTH. PERSONALITY. CHARISMA.  
THOSE WHO HAVE IT DO NOT NEED TO PROVE IT.  
WHOEVER MEETS IT RECOGNISES IT IMMEDIATELY.





# 2

## LUXURY MUST AROUSE EMOTIONS.

Searching and finding modern perfection: Adrian van Hooydonk, chief designer at the BMW Group, on the new appearance in the segment of the most exclusive vehicles.

The models under the name Bayerische Motoren Werke open up a new world within the BMW portfolio. What is your idea of contemporary luxury?

We do not want to tell our customers how they should define luxury for themselves, but just want to make an attractive, diverse offer. The perception of luxury is very different worldwide. But a central aspect that becomes visible everywhere is the increasing significance of personal time. It is becoming the most valuable asset in a globalised world.

How is the wish for perfection and refinement expressed in mobility?

In today's mobile world, we spend more and more time in various modes of transport. Cars are now like personal rooms on wheels. One wants to feel completely comfortable in them. A steering

wheel that you touch, the materials that surround you have to feel perfect and the eye does not want to be disturbed by unclear lines or individual components. The interior of a vehicle is seen as a living space. It is about being surrounded by the highest possible sensuous quality.

What is the biggest challenge in the external appearance?

Luxury must be reflected to the outside world in a matter-of-fact way. There is a beautiful term for it: sophistication. For designers – our team has more than 700 employees at four locations worldwide, who are encouraged through constant competition with each other in terms of ideas – this means that every detail counts. The design has to arouse strong emotions while expressing the highest quality and durability at the same time. In order to be able to spend every moment intensely, full of meaning and beauty. Therefore, we are building a luxury ecosystem, a model family. In various forms of expression: contemporary saloons, elegant and very sporty coupés, but also vehicles that offer very luxurious space.

In the new designs, a common factor is noticeable: the reduction of lines. Do you want to increase luxury by making luxury less apparent in the design?

In this way, the design becomes clearer, more modern and more emotional. An expressive surface play is in the foreground, and the dynamics are emphasised even more than before by the vehicle body. The few but very precise vehicle lines underline the graphic design of the surfaces. The vehicle body looks more powerful, refined and luscious with the lavish surfaces without losing the sportiness that is typical to BMW. This is possible only because we work out every feature of a vehicle individually. For a BMW, one should be able to identify at first glance what kind of experience one would have with it. Especially in our large and particularly luxurious vehicles, we attach great importance to a marked appearance and the maximum possible feel-good factor in the interior. It's about freedom – and the feeling of being at home in a BMW.







FOCUSED EXPRESSIVENESS FOR  
MAXIMUM SECURITY: THE BMW LASERLIGHT.

Great personalities are characterised by a striking look. The dynamically contoured, hexagonal full-LED headlights with adaptive bend lighting lend the BMW X7 unique expressiveness. Visually highlighted by blue accent clasps and the “BMW Laser” lettering, the BMW Laserlight<sup>1</sup> provides additional driving comfort with a range of up to 600 m in high beam mode.

<sup>1</sup> Available as optional equipment.



THE SUMP GUARD INTEGRATED INTO THE FRONT APRON IS  
DESIGNED IN ALUMINIUM SATINATED<sup>1,2</sup> AND AT THE SAME TIME  
LOOKS LUXURIOUS AND FUNCTIONAL.

<sup>1</sup> Available as optional equipment.

<sup>2</sup> Only available in conjunction with additional equipment.

A STATEMENT THAT ATTRACTS  
EVERYONE'S ATTENTION: THE LARGE,  
UPRIGHT BMW KIDNEY GRILLE.

The large, emphatically vertical kidney grille forms the heart of the impressive front design. Its massive presence stands in charming contrast to the very slim front headlights. Both kidney grille elements are connected to form a monolithic unit – the largest double kidney grille in the BMW range.

## IMPRESSIVE. EXPRESSIVE. UNMISTAKABLY X.

Overwhelming presence, precise simplicity and discreet glamour. With its symphony of shapes, surfaces and lines, the exterior design of the BMW X7 is a work of art that combines confidence, superiority and sheer presence with sporty elegance. With its imposing upright silhouette, the front already sets an example of power and dominance that can hardly be tamed. The heart is the large, opulent kidney grille. A play of striking lines and generous surfaces characterises the athletic, modern side view just as much as refined design elements. And the rear also shows determination and superiority. With the first BMW X7, a spectacular appearance always succeeds.



GLOSS-LATHED EYE-CATCHING MAGNET:  
THE ELEGANT WHEEL DESIGN.

At 22 inches, the light alloy wheels Multi-spoke style 757<sup>1,2,3</sup> are among the largest wheels in the portfolio and thus radiate an unmistakable presence in the side perspective. In Ferric Grey and gloss-lathed, they look particularly noble.

<sup>1</sup> Available as optional equipment.

<sup>2</sup> Only available in conjunction with Design Pure Excellence.

<sup>3</sup> Not available for M50d.







JACEK FRÖHLICH,  
HEAD OF TOP-CLASS DESIGN, BMW



HADI TEHERANI  
ARCHITECT AND DESIGNER

## ON THE ART OF SHOWING TRUE GREATNESS.

A CONVERSATION ABOUT LUXURY, SPACE FEELING AND THE FIRST BMW X7 – WITH THE HEAD OF TOP-CLASS DESIGN AT BMW JACEK FRÖHLICH AND STAR ARCHITECT HADI TEHERANI.

Mr. Fröhlich, Mr. Teherani, how is exciting design created?

**Fröhlich:** The proportions play a very important role – in design there must always be the question of how the bigger picture fits together, how everything is perfectly coordinated. Only then do the lines and materials that give the vehicle its form and character traits such as dynamism, tranquillity, casualness or luxury come into play.

**Teherani:** To make a room work, you have to stage it. And here we have many possibilities to say what we want to express. As an architect, for example, I choose a vehicle according to how the model affects me from the inside. I need to feel comfortable and have an overview of the bigger picture.

How can spaciousness be staged that looks elegant and sophisticated at the same time?

**Teherani:** Just as a philosopher expresses himself through words and writing, we can do this through spaces. Quite an extreme example: When you enter a cathedral, the height and size of the room suggest something. The individual should feel small and be impressed by the omnipotence.

**Fröhlich:** In automotive design, this is a fine line, because we naturally want to create something new and exciting. We want to arouse enthusiasm. And size is an important factor here. The real art is to never make the mistake of promising more from the outside than we can deliver in the interior. If you take a look at the BMW X7, you can see a high driver's cab on the outside, which suggests an extraordinary amount of space inside. A promise we'll keep.

**Teherani:** And then it's the details that make a large room seem really pleasant. You can direct things the way you need them through proportions and details.



What should people feel when they enter the BMW X7?

**Teherani:** Depending on the design, a room like a car can embrace or reject you. And when you're in a vehicle, you want to feel safe.

**Fröhlich:** I find spaciousness itself fascinating. The interior of the BMW X7, for example, is not only tailored to the driver, but also offers undreamt-of space for all occupants, and this space is intended to arouse certain emotions through its aesthetics and equipment. In the interior, we enclose the passengers by running a continuous line from front to back. This gives the occupants the feeling of being embraced, which is very evident in the cockpit, for example. And that creates a feeling of freedom and security at the same time.

**Teherani:** In architecture, we say: Space is luxury. The larger the room, the more luxury is possible. You might get by with less space, but generosity is a beautiful feeling that we can create with our work. It's a desirable form of luxury.

Is it easier to design something very big or something small?

**Fröhlich:** As an automotive designer, I am confronted with the challenge that everything always changes proportionally – apart from people. The challenge is therefore always to give a specific space the right impetus. The requirements for the design process are independent of the size – but a larger space offers more possibilities. For the designer. And finally for the customer.

**Teherani:** It is very similar in architecture. Of course, we are working with extremely large dimensions when, for example, we develop a train station that is 700 metres long. The attraction, however, always lies in finding a solution at that moment – no matter whether you are designing something small or something very big.

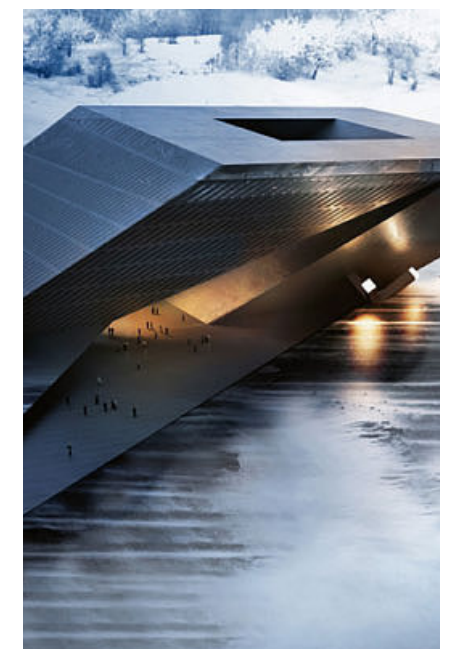

UNITED AIRCRAFT CORPORATION  
OFFICE BUILDING ZHUKOVSKY, RUS 2011  
HADI TEHERANI ARCHITECTS GMBH



## LUXURY TRAVELS.

MORE ROOM FOR PERFECTION:  
A BRIEF LOOK AT THE FUTURE OF  
PERFECT TRAVEL – IN THE BMW X7.

Luxury knows no boundaries. But it is only when travelling that it becomes apparent whether luxury concepts meet their high standards. The most important parameters for travellers have always remained the same: maximum intimacy, effortless comfort and groundbreaking speed. A journey is only perceived as a pleasure when it is fast, pleasant, every moment is special – and a maximum of private space is available. This basic principle runs through the history of demanding travel, from luxury trains and yachts to private jets and spacious cars. Speed is increasingly smartly influenced by autonomous systems, while privacy and comfort are becoming increasingly important in the art of pleasurable travel. The overall result: We experience new, perfectly shaped ways in vehicle construction.

In terms of exterior perception, the BMW X7 does what many supposed luxury concepts fail to do: Distinction through presence. The largest kidney grille in the range makes a statement. The interior opens up completely new perspectives, and the combination of refinement and comfort becomes a unique selling point. Excellence meets generosity, experienced through enormous leg and headroom and a unique space offer, with space for up to seven seats – while alternatively six seats<sup>1,2</sup> guarantee even more privacy on two individual comfort seats<sup>1</sup> in the second row.

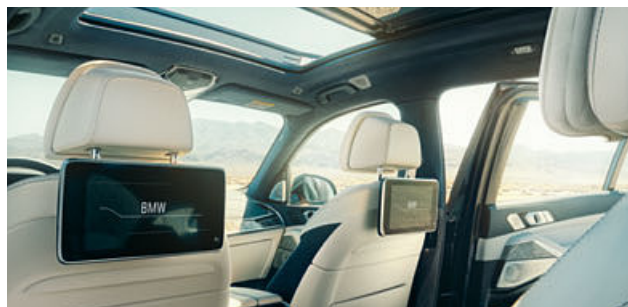

And they enable completely new perspectives – from the starry sky of the Sky Lounge<sup>1</sup> to the Panorama glass roof, which creates a feeling of space flooded with light that jet manufacturers can only dream of. Because the most important thing when travelling – and this is often forgotten – is neither arriving nor the way. It is the awareness that you never have to limit yourself in your perception. This is the true luxury of travelling.

The happiness of perfect comfort makes every moment and every longer journey special. The equipment makes the difference. A Bowers & Wilkins Diamond surround sound system<sup>1</sup> with 20 speakers creates a 3D sound experience that delivers its full resonance even in large spaces. In the interior, a finely tuned ambient light creates its own atmosphere and the BMW Individual full leather trim in Ivory White and Midnight blue<sup>1,2</sup> creates a special feel – while the Rear-seat entertainment Professional with two 10.2" displays allows the rear passengers to watch films independently of each other or offers the charming idea of e.g. sharing a blockbuster in theatre mode with the next seat neighbour. That is distinction par excellence. Luxury standards are shifting, and completely new comfort zones are being discovered.

## STRIVING FOR EXCELLENCE.

The BMW X7 allows a fresh look while being on the move. And sets a new standard for luxury. Namely, the question whether every single moment is really a pleasure. Without making a difference whether the pleasure comes from the experience of the surroundings – or from the comfort inside the vehicle. We discover the maximum appreciation of the moment. And a new form of travel.

<sup>1</sup> Available as optional equipment.

<sup>2</sup> Only available in conjunction with additional equipment.







#### ALWAYS THE BEST SEATS: TWO INDIVIDUAL SEATS IN THE SECOND ROW OF SEATS.

Six seats – and each one is the best place: If you choose the 6-seater configuration<sup>1,2</sup> of the first BMW X7, you will find two individual comfort seats in the second row instead of a full-length 3-seater bench. This allows you to enjoy numerous advantages: The two seats offer two travellers not only the greatest possible privacy, but also maximum seating comfort: Lean back on the comfort cushion in the headrest, place your arm on the armrest in the middle and let the landscape pass by. An additional plus: The two individual seats make access to the third row of seats even quicker and more comfortable – for maximum flexibility in every situation. If you want to take even more people with you, the 7-seater is just the thing: On the full-length bench in the second row of seats, three passengers have comfortable space. No matter which variant you choose, in the BMW X7 you will always be sitting in the best seats.

<sup>1</sup> Available as optional equipment.

<sup>2</sup> Only available in conjunction with additional equipment.

#### A FEAST FOR THE EYES: THE DYNAMIC INTERIOR LIGHTING.

The dynamic interior lighting immerses the interior in an unparalleled atmosphere that combines the best of ambient, indirect lighting with highlights. Numerous LEDs and optical fibres can be controlled in several adjustable colours. When entering and exiting or during events such as a telephone call, preconfigured, dynamic lighting effects create an eye-catching visual experience through the harmonious interaction of all lighting elements.

#### LIKE ON CLOUDS: SEATING COMFORT THROUGH MASSAGE FUNCTION.

The comfort seats<sup>1</sup> of the BMW X7 immerse you in an overwhelming feeling of relaxation and comfort. You can also activate the massage function<sup>1,2</sup> at the touch of a button, which feels like a spa visit for driver and front passenger. Experience eight massage programmes dedicated to different parts of the body. According to your wishes, you can choose between three intensity levels. The muscles are specifically relaxed or activated – and your physical well-being is increased on every ride.

<sup>1</sup> Available as optional equipment.

<sup>2</sup> Only available in conjunction with additional equipment.

## THE MOST BEAUTIFUL LUXURY: FREE SPACE.

The luxury of space and freedom: In the BMW X7, every journey is a moving moment – even when stationary. Be it the refined cockpit, the individual seats in the second row or the comfortable third row, which can be steered like a functional ballet – you always have the best seat. Like a piece of jewellery, precious materials lie on sophisticated sculptural forms and crown the interior. Combined with an infinite amount of space, the interior is the soul of the unique work of art that is the BMW X7.



#### POLISHED HAUTE COUTURE: THE GLASS APPLICATION 'CRAFTED CLARITY'.

The hand-crafted glass applications<sup>1</sup> are an experience for the hands and the eyes: They set high-quality highlights on selected control elements such as the gear selector, the Start-Stop button, the iDrive Controller or the volume control, which further add to the already noble ambience.

<sup>1</sup> Available as optional equipment.





#### GAME CHANGER: THE DRIVING EXPERIENCE WITH EXECUTIVE DRIVE PRO.

The Executive Drive Pro<sup>1,2</sup> suspension control system is the result of the highest level of engineering skill, which ensures driving performance that is characterised by stability and harmony in every situation. Even when cornering dynamically, body roll is reduced to a minimum. But even on straight roads, the sophisticated interplay of active body roll stabilisation of the front and rear axles, adaptive suspension and information from the navigation system, driving style analysis and the camera's forecast data ensures an incomparably confident and pleasant feeling of superiority and lightness that makes every journey even more dynamic and relaxed at the same time: Two souls in harmony – with Executive Drive Pro.

<sup>1</sup> Available as optional equipment.

<sup>2</sup> With xDrive50i and M50d only available in conjunction with other equipment.

#### JUST THE RIGHT LEVEL: THE ADAPTIVE 2-AXLE AIR SUSPENSION.

Unsurpassed comfort with maximum dynamics – the Adaptive 2-axle air suspension including the adaptively controlled shock absorber system combines both. Like a conductor, the air suspension keeps the vehicle at a constant height regardless of the load. The vehicle automatically lowers at higher speeds, reducing drag and fuel consumption. Be it lowering for more driving dynamics or an elevation for off-road use – by means of a toggle switch in the centre console, five different height levels can be conveniently selected within an adjustment range of 80 mm.



## THIS IS HOW EXCELLENCE IS DRIVEN.

A driving experience in a BMW is always extraordinary – and the first BMW X7 sets a new standard for this: Equally comfortable, fascinatingly luxurious and excitingly dynamic, this is an impressive example of what happens when technological visions become reality.

#### FOUR WORLDS, NO COMPROMISES: THE xOFFROAD PACKAGE.

No matter what terrain – the xOffroad package<sup>1,2,3</sup> enables maximum traction and absolute safety on all roads. It is operated conveniently via the xOffroad Driving Experience Control and allows the selection between the modes xSand, xRocks, xGravel and xSnow. Depending on the selected surface, the transmission characteristics are adapted and, together with the mechanical differential lock, ensure uniquely superior and controlled handling even on challenging terrain. A specific display in the instrument cluster and in the Control Display provides additional information, and a sump guard at the front ensures the necessary functionality. The xOffroad package therefore combines design, form and functionality in a special way so that every voyage of discovery is both safe and uniquely exciting.

<sup>1</sup> Available as optional equipment.

<sup>2</sup> For xDrive50i only available in conjunction with additional equipment.

<sup>3</sup> Not available for M50d.





# 3

## EMOTION EXPRESSED AS INNOVATION.

Thoughts were born, ideas thought through  
and know-how taken to the extreme.  
Innovative technologies were developed,  
comfort and efficiency enhanced and  
performance levels increased. But all this  
was not done to put knowledge, ability  
and pioneering spirit in the foreground –  
but to make this one, special feeling  
even more tangible: Driving pleasure.  
Technology becomes emotion –  
Bayerische Motoren Werke.





# SUPPORTS WITHOUT DISTRACTING.

## DRIVER ASSISTANCE

The intelligent assistants of BMW Personal CoPilot are available for every vehicle of the Bayerische Motoren Werke. These support you in all driving situations and increase safety and comfort. In this way, you ensure that you can look forward in a relaxed manner and devote yourself to the most important thing: sheer driving pleasure. Today, tomorrow and also in the future: The driver assistance systems in a vehicle from the Bayerische Motoren Werke define what is technically feasible – and as a reliable companion, ensure that you master every challenge with confidence.



### BACKWARDS AS EASY AS FORWARDS: THE REVERSING ASSISTANT.

Be it a driveway or a mountain pass: Reversing can sometimes become a real challenge. Here it's reassuring to have an all-knowing assistant with you. The Reversing Assistant<sup>1,2</sup> relieves you of this unpleasant task: It stores the last 50 m of the driven path when driving up to 35 km/h. If you want to reverse, it takes over the steering and you can fully concentrate on monitoring the vehicle surroundings. Even narrow or winding roads and parking or manoeuvring situations lose their horror.

<sup>1</sup> Available as optional equipment.  
<sup>2</sup> Part of the Parking Assistant and Parking Assistant Plus packages.



### IS THERE WHEN REQUIRED: DRIVING ASSISTANT PROFESSIONAL.

A reassuring feeling: Driving Assistant Professional<sup>1</sup> includes all intelligent and innovative assistance systems that make driving more comfortable and safer, for example on monotonous routes, in stop-and-go traffic or in confusing situations. Semi-automated functions such as the Active cruise control with Stop&Go function and functions such as the automatic Speed Limit Assist support the driver by automatically holding and adjusting the speed and distance to the front vehicle, while the Lane keeping assistant with active side collision protection can prevent unintentional lane departure by intervening in the steering, making every journey even easier and safer thanks to hidden intelligence.

<sup>1</sup> Available as optional equipment.

### SAFETY FIRST: CROSSROADS WARNING WITH LIGHT CITY BRAKING FUNCTION.

Traffic lights, traffic signs and crossing vehicles – the Crossroads warning with light city braking function<sup>1,2</sup> detects potential sources of danger and can help to avoid accidents. The system actively supports the braking process and alerts the driver with a visual and acoustic warning. Even if a collision cannot be avoided, the system intervenes and reduces the impact speed to reduce damage.

<sup>1</sup> Available as optional equipment.  
<sup>2</sup> Part of the Driving Assistant Professional package.







# CONNECTED DOWN TO THE SMALLEST DETAIL.

## CONNECTIVITY AND INFOTAINMENT



### WIRELESSLY CONNECTED IN THE BEST WAY: TELEPHONY WITH WIRELESS CHARGING.

Your digital world, integrated into your BMW X7: Not only wireless charging becomes very easy thanks to the integrated wireless charging dock. You can also connect up to two mobile phones and a mobile audio player to your vehicle via Bluetooth – and transfer contact photos from the address book and SMS messages to the Control Display. With WiFi hotspot preparation, you can surf the Internet at LTE speed and enjoy optimal cellular reception thanks to the roof aerial connection. But even conversations are getting better: A second microphone provides ideal hands-free quality for you and your front passenger and helps to effectively eliminate noise from the front passenger and rear passenger areas.<sup>1,2,3</sup>

<sup>1</sup> Available as optional equipment.

<sup>2</sup> Inductive charging for Qi-compatible mobile phones is possible. Special charging cases are available from Original BMW Accessories for selected smartphones that do not support Qi inductive charging.

<sup>3</sup> The WiFi hotspot fulfils all in-vehicle requirements for use of the internet with the maximum LTE standard. Usage is subject to cost.

### OPEN TO NEW EXPERIENCES: THE DIGITAL KEY.

With the Digital Key<sup>1</sup>, the signature of the vehicle key is easily stored in the BMW Connected App of your smartphone. The door handle of the BMW X7 recognises this signature and opens the door – safely, reliably and without the need for a separate key. Even several key signatures can be created at the same time, allowing even a simple and uncomplicated lending of the vehicle from a distance.

<sup>1</sup> Part of the Comfort access package.

### INNOVATIVE INFORMATION: BMW LIVE COCKPIT PROFESSIONAL WITH INNOVATIVE OPERATING CONCEPT.

The innovative BMW Live Cockpit Professional with a learning navigation system is a new highlight of BMW's typical driver orientation. All information is displayed in an appealing manner on the display network consisting of a Control Display and an instrument display. Thanks to the individually configurable operating concept of the BMW Operating System 7.0, an even more intuitive operation via gestures, speech, touch screen and iDrive control is possible. With the enhanced functionality of the controller, all digital services such as apps<sup>1</sup> can be selected directly and the whole system can be configured according to personal preferences.

<sup>1</sup> Available as optional equipment.

To stand above it all and yet stay completely connected with your world: When it comes to connectivity and infotainment, Bayerische Motoren Werke does not want to follow any trends, but set standards. With BMW ConnectedDrive, you are optimally connected wherever you are, and you have access to the full range of communication, information and entertainment at any time. In addition, the personal mobility assistant BMW Connected also accompanies you on your smartphone outside the vehicle and supports you in your everyday life – because sheer driving pleasure starts long before you get in and does not stop when you get out of the car.

### SMOOTHED SOUND FOR PURE SOUND ENJOYMENT: THE BOWERS & WILKINS DIAMOND SURROUND SOUND SYSTEM.

Seven aluminium Kevlar midrange speakers. Five aluminium tweeters. Two diamond tweeters. Two subwoofers with Rohacell core. Four broadband loudspeakers in the headliner for the 3D sound effect. In addition a 10-channel amplifier and a microphone-supported dynamic driving sound regulation, which supplies excellent sound through discreet control of the loudspeakers in each driving situation: The Bowers & Wilkins Diamond surround sound system<sup>1</sup> blends selected materials and high-end technology to create a unique, high-end audio experience.

<sup>1</sup> Available as optional equipment.

### THEATRE VISIT IN THE REAR: THE REAR-SEAT ENTERTAINMENT PROFESSIONAL.

A top class entertainment experience also in the rear: Two independently tilt-adjustable, touch-sensitive 10.2" HD displays and audio playback via loudspeakers or headphones create a real cinema atmosphere on every seat. Thanks to the additional Blu-ray drive in the rear, access to the entertainment functions of the BMW X7 and the option of connecting MP3 players or game consoles, there's no chance of boredom – no matter how long the journey.<sup>1</sup>

<sup>1</sup> Available as optional equipment.

Some ConnectedDrive Services may differ between countries. Please consult your local BMW partner for more information.



# EXPERIENCE WITH ALL YOUR SENSES.

COMFORT AND FUNCTIONALITY



Vehicles from the Bayerische Motoren Werke not only stand for unlimited driving pleasure, but also for particularly sophisticated motoring enjoyment. Everything around you is designed for maximum comfort and maximum functionality. From atmospheric light design when entering the vehicle to perfect sound from the high-end sound systems to the pleasant Multifunction seats: Everything here is designed to turn even an everyday trip into an extraordinary experience.

## REFINED AT ALL TEMPERATURES: THE HEAT COMFORT PACKAGE FRONT.

Well-warmed arms and hands even on cooler days: With the Heat Comfort package at the front<sup>1</sup>, goosebumps are triggered only by the overwhelming feeling of space, but certainly no longer by the cold season. Along with the front seats, the armrests on the doors and front centre console, as well as steering-wheel are heated. The driver and front passenger select their individual temperature simply via the iDrive menu and seat heating button, so that everyone can create their own pleasant ambience.

<sup>1</sup> Available as optional equipment.

## ALWAYS THE RIGHT DEGREE: THE TEMPERATURE-CONTROLLED CUPHOLDERS.

Warming coffee or refreshing water – those on the move will always enjoy their drinks at the right temperature in the first BMW X7. No matter how you like your drink: The temperature-controlled cupholders<sup>1</sup> always serve you the right temperature. They can be cooled or heated separately at the touch of a button. The coloured ambient light also indicates at first glance whether the drinks are being cooled or warmed by means of a noble-looking illumination in red or blue inside the cupholders. So the last sip remains as good as the first even while travelling.

<sup>1</sup> Available as optional equipment.

## WELL THOUGHT-OUT RIGHT TO THE END: THE AUTOMATIC AIR CONDITIONING WITH 5-ZONE CONTROL.

Too cold! No, too hot! Do you recognise it? When different people are sitting in a vehicle, their ideas about what temperature feels comfortable can be quite different. But thanks to the automatic air conditioning with 5-zone control<sup>1</sup>, the first BMW X7 is a dream car for every climate. Both the driver and front passenger areas, the left and right sides of the second row of seats and the third row of seats can be tempered according to the respective preferences. Whether pleasantly warm, refreshingly cool or individually in-between – here everyone can find their own comfortable temperature and, thanks to the separate operating option for each area, can also control it themselves.

<sup>1</sup> Available as optional equipment.





# 4

## ONLY YOUR OWN WAY LEADS TO YOUR OWN GOALS.

Materials – hand crafted,  
exquisite and exclusive. Colours, surfaces  
and shapes as individual as the eyes that  
look upon it. Ideas and expectations are  
met without compromise – and exceeded.  
Emotion is the consequence of design:  
Bayerische Motoren Werke.





# BMW INDIVIDUAL.

THE EXPRESSION OF PERSONALITY.

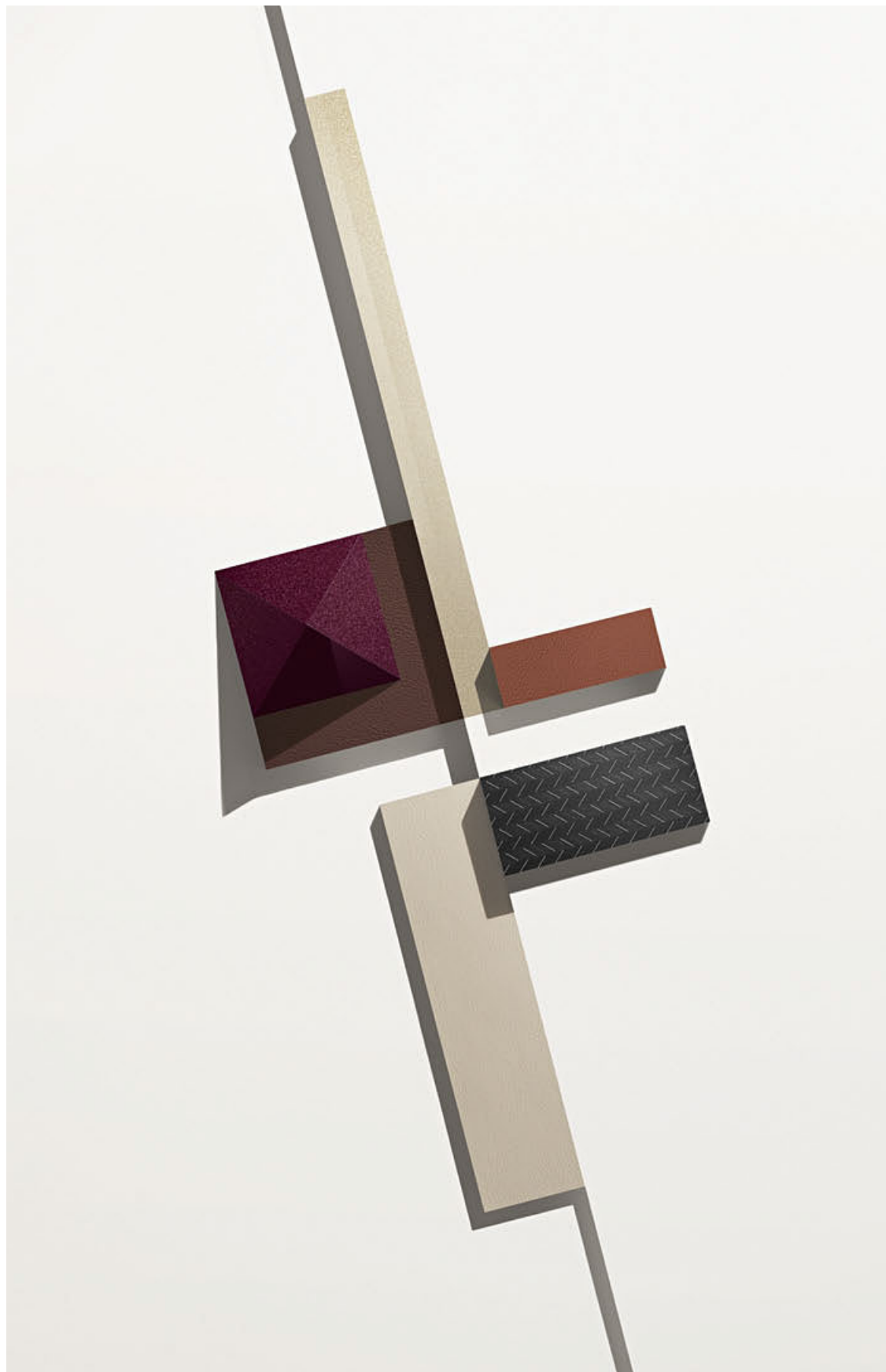

Let yourself be inspired: This artistic design shows an exclusive selection of the material diversity of BMW Individual for the first BMW X7.

## SPACE FOR WHAT IS BEYOND IMAGINATION. AND YOUR IDEAS. THE FIRST BMW X7 – INSPIRED BY BMW INDIVIDUAL.

The BMW X7 already leaves nothing to be desired in the standard equipment. BMW Individual takes you one step further: Even more extraordinary, even more exclusive – the possibilities of BMW Individual are limitless. Whether you choose from particularly high-quality equipment options for the exterior and interior or fulfil your very own dream of your individual BMW X7 – with BMW Individual you have every option open to you. Let yourself be inspired!

The BMW Individual paint finish in Ametrine metallic is particularly eye-catching due to its rich colour brilliance and the unique colour-shifting effect. The reason for this is the Xirallic pigment, which creates a dazzling glittering effect through the addition of metal flops, which even increases in sunlight – a unique paint finish for a unique vehicle.

Available from 08/2019.



A brilliant appeal: The deep shine of the BMW Individual interior trim finishes in piano finish Black is the result of an elaborate process in which several layers of wood veneer are applied and then painted and polished in numerous layers with piano finish. The result: a unique surface that shines with noble brilliance.



The BMW Individual extended leather upholstery 'Merino' in Coffee illustrates the claim to excellence of BMW Individual: Only premium quality leather without any surface defects is used, which is not subjected to any artificial embossing or surface treatment during the production process after an elaborate dyeing through barrel pigmentation.



DISCOVER THE WHOLE RANGE OF BMW INDIVIDUAL EQUIPMENT FOR THIS MODEL. WITH THE BMW CATALOGUES APP FOR iOS AND ANDROID.



BMW INDIVIDUAL MEANS:  
GIVING FORM TO THE EXTRAORDINARY.  
MAKING AUTOMOTIVE DREAMS COME TRUE.



DISCOVER THE WHOLE RANGE OF BMW INDIVIDUAL EQUIPMENT FOR THIS MODEL. WITH THE BMW CATALOGUES APP FOR iOS AND ANDROID.



# WHICH COLOUR GIVES YOU DRIVING PLEASURE?

## EXTERIOR COLOUR WORLD

Phytonic Blue or Vermont Bronze? Manhattan or Ametrine?  
The extroverted metallic colour palette for the first BMW X7 will leave you spoiled for choice. For whichever paintwork you decide: You always choose ground-breaking design and uncompromising dynamics, which prove passion and character.

■ STANDARD EQUIPMENT □ OPTIONAL EQUIPMENT

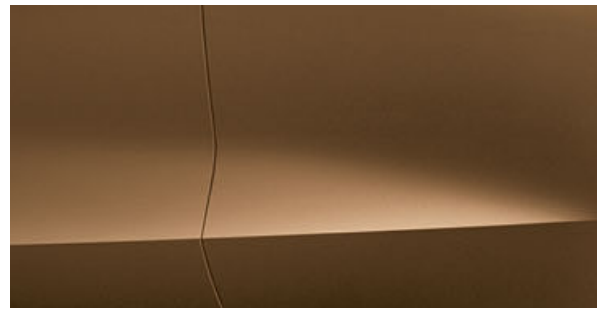

■ Non-metallic 300 Alpine White<sup>5</sup>



■ Non-metallic 668 Black<sup>3,3</sup>



□ Metallic C27 Arctic Grey brilliant effect<sup>2</sup>



□ Metallic 475 Black Sapphire<sup>2</sup>



□ Metallic A96 Mineral White<sup>2</sup>



□ Metallic A90 Sophisto Grey brilliant effect<sup>2</sup>

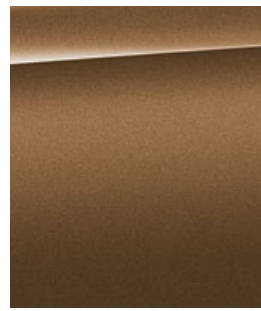

□ Metallic C1Z Vermont Bronze<sup>1</sup>

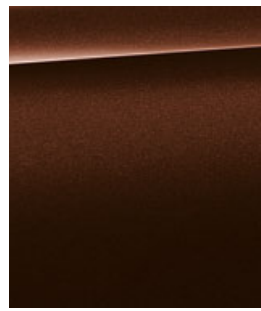

□ Metallic C1L Terra Brown<sup>3</sup>



□ Metallic C1M Phytonic blue<sup>1</sup>

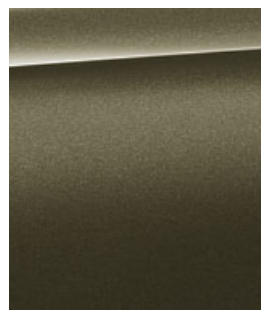

□ Metallic C3D Manhattan<sup>4</sup>



### BMW INDIVIDUAL



□ Metallic C1N Sunstone<sup>2</sup>

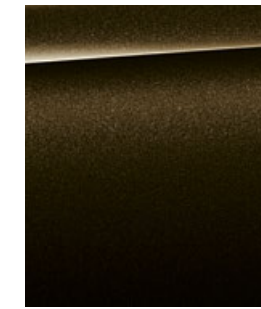

□ BMW Individual X13 Pyrite Brown metallic<sup>2,4</sup>



□ BMW Individual X1B Ametrine metallic<sup>2,4</sup>



□ BMW Individual X03 Ruby Black metallic<sup>2,4</sup>

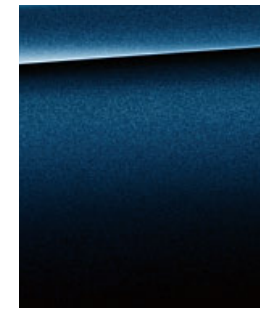

□ BMW Individual C3Z Tanzanite Blue metallic<sup>2,4</sup>

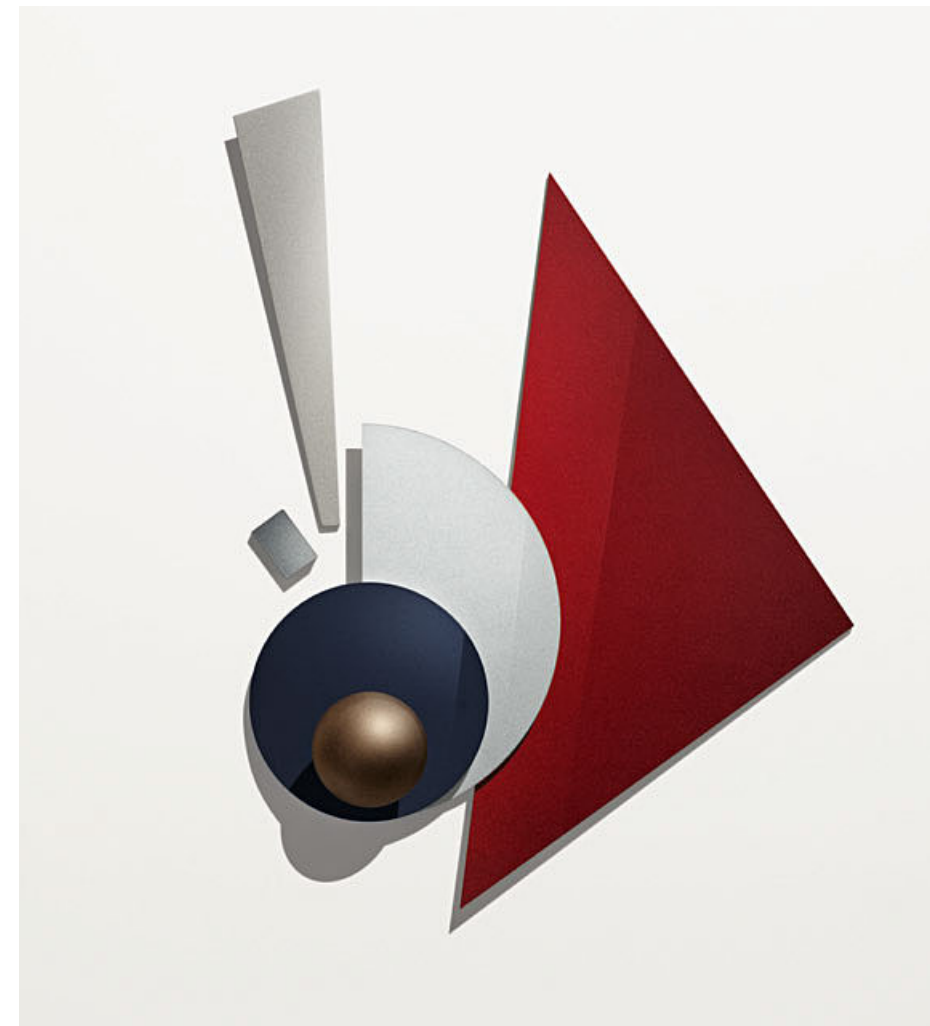

Infinite colour diversity. You want an individual paint finish? BMW Individual is on hand to advise you on your choice.

### M SPORT PACKAGE

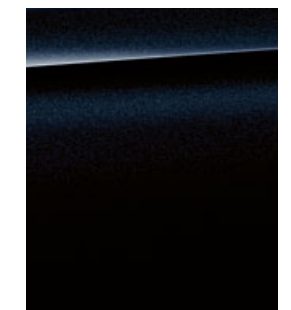

□ Metallic 416 Carbon Black

**[Colour samples]** These colour samples are intended as an initial guide to the colours and materials available for your BMW. However, experience has shown that printed versions of paint, upholstery and interior trim colours cannot in all cases faithfully reproduce the appearance of the original colour. Please discuss your preferred colour choices with your BMW partner or dealership. There you can also see original samples and be assisted with special requests.

<sup>1</sup> Not available for M50d.

<sup>2</sup> Optionally available for the M Sport package.

<sup>3</sup> Available from 04/2019.

<sup>4</sup> Available from 08/2019.

<sup>5</sup> Standard with the M Sport package and base model until 04/2019.

The Standard and Optional equipment may differ between countries. Please consult your local BMW partner for more information.





# AN OVERWHELMING APPEARANCE.

CREATED IN AESTHETIC PERFECTION



INCOMPARABLE EXCLUSIVITY: THE BEAUTY OF THE INTERIOR TRIM FINISHERS IN BMW INDIVIDUAL FINE-WOOD TRIM ASH GRAIN SILVER GREY HIGH-GLOSS<sup>1</sup> CREATES AN ENSEMBLE THAT LETS PRECIOUSNESS BE FELT DOWN TO THE SMALLEST DETAIL.

Under a BMW Individual headliner made of Alcantara<sup>1</sup>, the BMW Individual full leather trim 'Merino' in Bicolour Ivory White/Midnight<sup>1,2</sup> blue creates an ambience whose luxurious impression is unique – just like the interior trim finishers in BMW Individual fine-wood trim Ash Grain Silver Grey high-gloss<sup>1</sup>, which gels harmoniously with the full leather trim and completes the high-quality ensemble.

<sup>1</sup> Available as optional equipment.  
<sup>2</sup> Only available in conjunction with additional equipment.

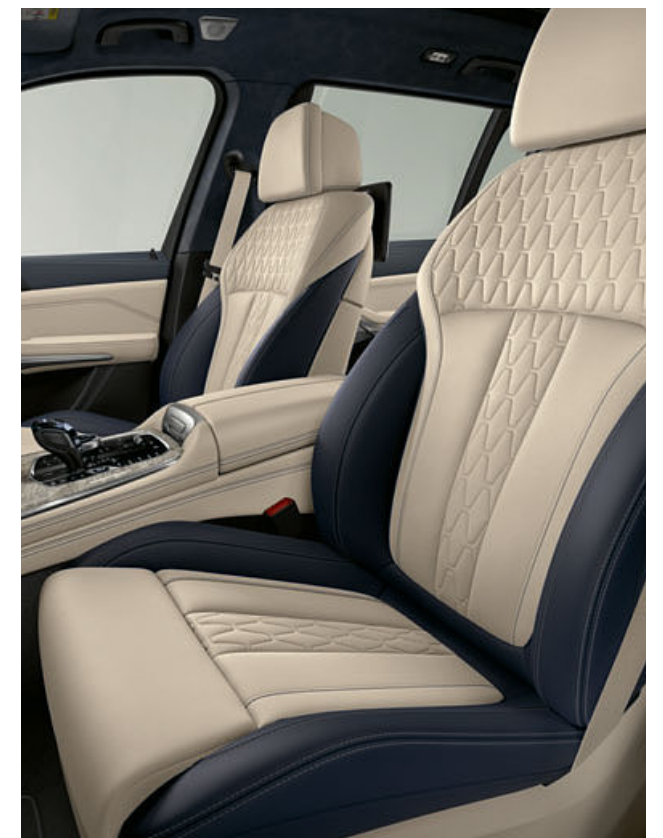

ITS COMBINATION OF IVORY WHITE AND MIDNIGHT BLUE LENDS THE BMW INDIVIDUAL FULL LEATHER TRIM 'MERINO' AN EFFECT THAT MAKES YOU FEEL THE NOBLE, HIGH-QUALITY CHARACTER THROUGH AND THROUGH.





# UNIQUE CHARACTER DESERVES UNIQUE STYLE.

REVOLUTIONARY CLASSIC



THE SHINE OF THE INTERIOR TRIM FINISHERS IN FINE-WOOD TRIM FINELINE BLACK WITH METAL EFFECT ADDS A CERTAIN SOMETHING TO THE CLASSIC ELEGANCE OF THE WOOD.

The BMW Individual extended leather trim 'Merino' in Tartufo<sup>1,2</sup> not only embodies a unique, timeless style. Complemented by the interior trim finishers in Fineline Black with metal effect high-gloss<sup>1,2</sup>, the result is an interior that makes your pulse beat faster as you board the car.

<sup>1</sup> Available as optional equipment.  
<sup>2</sup> Only available in conjunction with additional equipment..

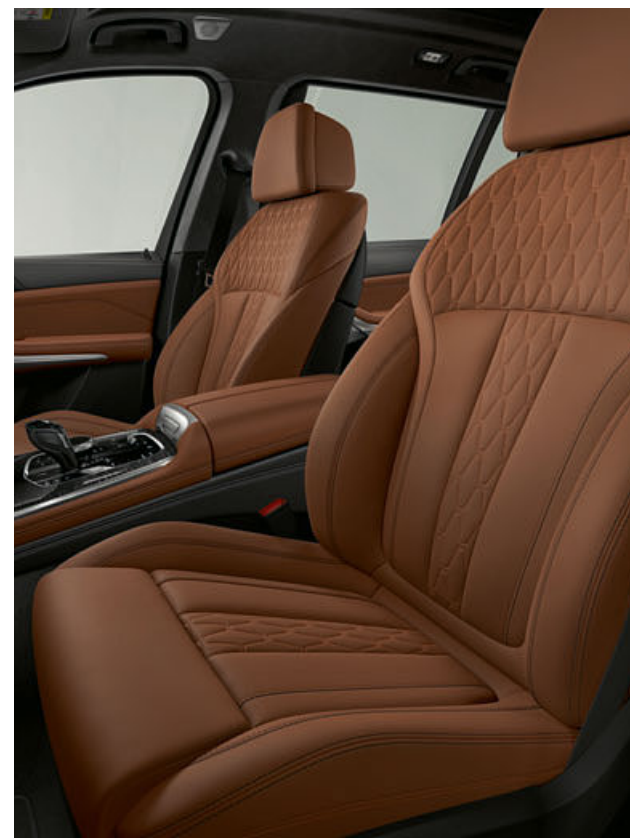
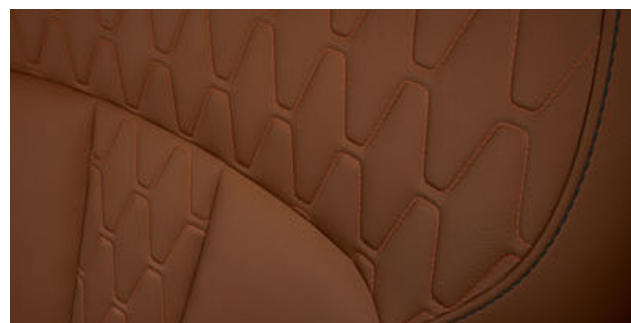

THE BMW INDIVIDUAL EXTENDED LEATHER TRIM 'MERINO' IN TARTUFO CONVINCES WITH THE FLAWLESS QUALITY AND EXTRAORDINARY HAPTICS OF THE BREATHABLE LEATHER AS WELL AS AN ESPECIALLY INTENSE COLOUR.

# A QUESTION OF STYLE.

ELEGANCE, BLACK ON WHITE

The essence of cultivated elegance and modern technical appeal: The BMW Individual full leather trim 'Merino' finely structured in Ivory White<sup>1,2</sup> forms the perfect symbiosis with the interior trim finishers in BMW Individual fine-wood trim 'Fineline' black with aluminium inserts.<sup>1,2</sup>

<sup>1</sup> Available as optional equipment.  
<sup>2</sup> Only available in conjunction with additional equipment.

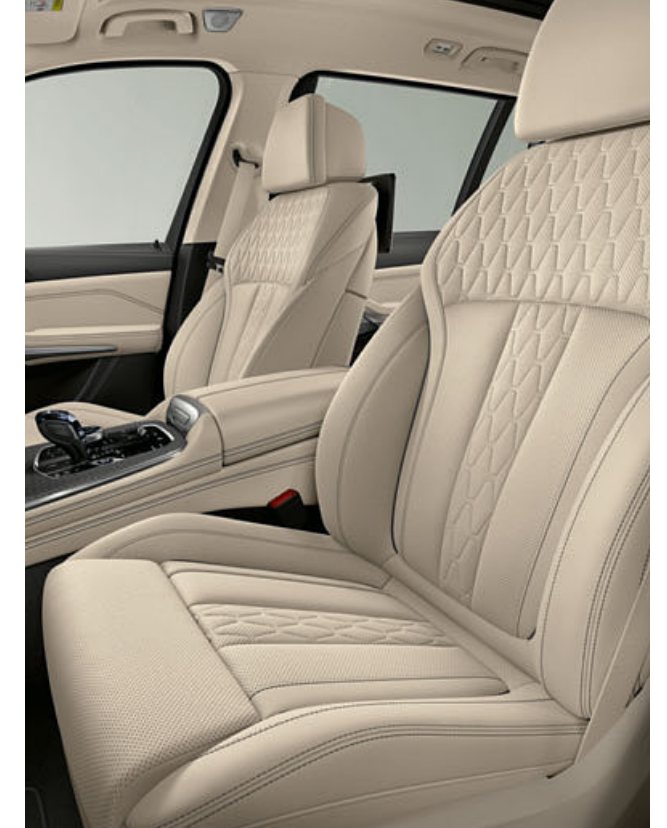

THE BMW INDIVIDUAL FULL LEATHER TRIM 'MERINO' FINELY STRUCTURED IN IVORY WHITE HAS STRIKING STITCHING, WHICH EMPHASISES THE EXCLUSIVE QUALITY OF THE EQUIPMENT.

THE INTERIOR TRIM FINISHERS IN BMW INDIVIDUAL FINE-WOOD TRIM 'FINELINE' BLACK WITH ALUMINIUM INSERTS HAVE A MODERN AND DELICATE LOOK THANKS TO THEIR PRECISELY DESIGNED ALUMINIUM ACCENTS.





# TECHNICAL VALUES.

		xDrive40i	xDrive30d	M50d
<b>Weight</b>				
Unladen weight EU <sup>1</sup>	kg	2395	2445	2535
Maximum permissible weight	kg	3155	3220	3290
Permitted load	kg	835	850	830
Permitted trailer load, unbraked <sup>2</sup>	kg	750	750	750
Permitted trailer load, braked, max. 12% gradient/max. 8% gradient <sup>2</sup>	kg	2200/2200	2200/2200	2600/2600
Luggage compartment capacity	l	326–2120	326–2120	326–2120
<b>Engine</b>				
Cylinders/valves		6/4	6/4	6/4
Capacity	cc	2998	2993	2993
Rated output/rated engine speed	kW (hp)/rpm	250 (340)/5500–6500	195 (265)/4000	294 (400)/4400
Max. torque/engine speed	Nm/rpm	450/1500–5200	620/2000–2500	760/2000–3000
<b>Power transmission</b>				
Type of drive		All-wheel	All-wheel	All-wheel
Standard transmission		Steptronic transmission	Steptronic transmission	Steptronic Sport transmission
<b>Performance</b>				
Top speed	km/h	245 <sup>6</sup>	227 <sup>6</sup>	250 <sup>3,6</sup>
Acceleration 0–100 km/h	s	6.1 <sup>6</sup>	7.0 <sup>6</sup>	5.4 <sup>6</sup>
<b>Consumption<sup>4,5</sup> – all engines conform to the EU6 standard</b>				
Urban	l/100 km	10.3–10.6 <sup>6</sup>	7.3 <sup>6</sup>	7.8–8.3 <sup>6</sup>
Extra urban	l/100 km	7.5–8.2 <sup>6</sup>	6.1–6.5 <sup>6</sup>	6.6–6.8 <sup>6</sup>
Combined	l/100 km	8.7–9.0 <sup>6</sup>	6.5–6.8 <sup>6</sup>	7.0–7.4 <sup>6</sup>
Exhaust emissions standard (type-certified)		EU6d-temp	EU6d-temp	EU6d-temp
CO <sub>2</sub> emissions, combined	g/km	198–205 <sup>6</sup>	171–178 <sup>6</sup>	185–193 <sup>6</sup>
Tank capacity, approx.	l	83	80	80
<b>Wheels/tyres</b>				
Tyre dimensions	km	275/50 R 20 W	275/50 R 20 W	285/45 R 21 Y
Wheel dimensions	km	8.5 J x 20	8.5 J x 20	9.5 J x 21
Material	km	Light alloy	Light alloy	Light alloy

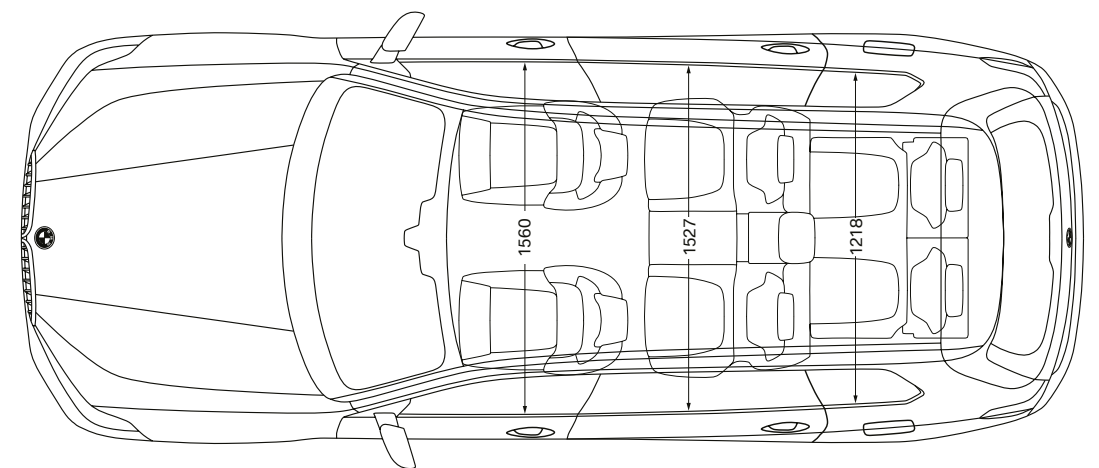
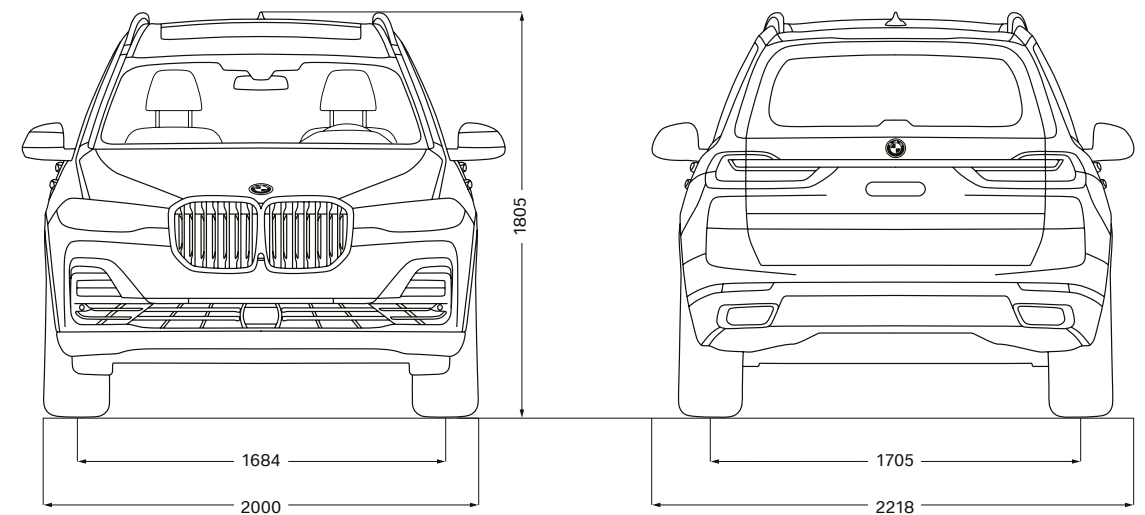
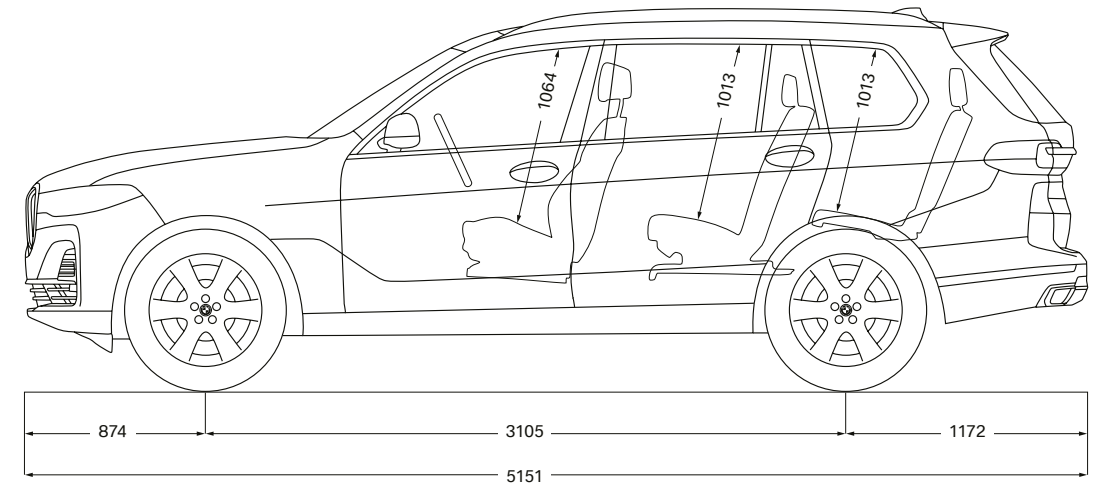

<sup>1</sup> The EC unladen weight refers to a vehicle with standard equipment and does not include any optional extras. The unladen weight includes a 90% full tank and a driver weight of 75 kg. Optional equipment may affect the weight of the vehicle, the payload and the top speed if the selected equipment has an impact on the vehicle's aerodynamics.

<sup>2</sup> The actual total weight of the trailer must not exceed the maximum trailer load, taking into account the maximum tow bar download.

<sup>3</sup> Electronically limited.

<sup>4</sup> Performance data of petrol engines apply to vehicles using RON 98 fuel. Fuel consumption data apply to vehicles using reference fuels in accordance with EU Regulation 2007/715.

Unleaded RON 91 and higher with a maximum ethanol content of 10% (E10) may also be used. BMW recommends RON 95 super unleaded petrol.

<sup>5</sup> The data for fuel consumption, CO<sub>2</sub> emissions and energy consumption are determined in accordance with the measurements processes as defined by European Regulation (EU) 2007/715 in the applicable version. Data refer to a vehicle with base-level equipment in Germany, and the ranges account for differences according to the selected wheel and tyre size and the optional equipment and may change during the configuration process. Figures have been determined on the basis of the new WLTP test cycle and have been converted back into NEDC figures for comparability. [For these vehicles, values other than those specified here may apply for the assessment of taxes and other vehicle-related charges that are (also) based on CO<sub>2</sub> emissions.]

<sup>6</sup> Provisional figures; any missing figures were unavailable at the time of publication.





The models illustrated in this brochure show the equipment and configuration options (standard and optional) for vehicles produced by BMW AG for the German market. Alterations in standard and optional equipment and the configurations available for the different models, as described in this brochure, may occur after 09/03/2018, the date when this brochure went to press, or according to the specific requirements of other markets. Your local BMW Partner is available to provide further details. Subject to change in design and equipment.

© BMW AG, Munich, Germany. Not to be reproduced wholly or in part without prior written permission of BMW AG, Munich. 411 007 342 20 2 2018 BC. Printed in Germany 2018.

**BMW Individual X7 xDrive40i with Design Pure Excellence:**  
BMW TwinPower Turbo 250 kW (340 hp) 6-cylinder petrol engine, 22" BMW Individual light alloy wheels Y-spoke style 758 Bicolour with mixed tyres, exterior colour in Ametrine metallic, comfort seats in BMW Individual full leather trim 'Merino' Ivory White, interior trim finishers BMW Individual fine-wood trim 'Fineline' black with aluminium inserts.

**BMW X7 xDrive40i:**  
BMW TwinPower Turbo 250 kW (340 PS) 6-cylinder petrol engine, 22" light alloy wheels Multi-spoke style 757 Bicolour with mixed tyres, exterior colour in Arctic Grey brilliant effect, comfort seats in BMW Individual full leather trim 'Merino' Ivory white/Midnight blue, interior trim finishers BMW Individual fine-wood trim Ash Grain Silver Grey high-gloss.



