



Sheer Driving Pleasure



THE NEW BMW X4.

BMW EFFICIENT DYNAMICS.
LESS EMISSIONS. MORE DRIVING PLEASURE.

THE NEW BMW X4.



M PERFORMANCE

DIGITAL DISCOVERY: THE NEW BMW BROCHURES APP.



More information, more driving pleasure: The new BMW brochures app offers you a brand new digital and interactive BMW experience. Download the BMW brochures app for your smartphone or tablet now and explore new perspectives of your BMW.

INNOVATION AND TECHNOLOGY.



18 Dynamics and efficiency
19 Drivetrain and suspension

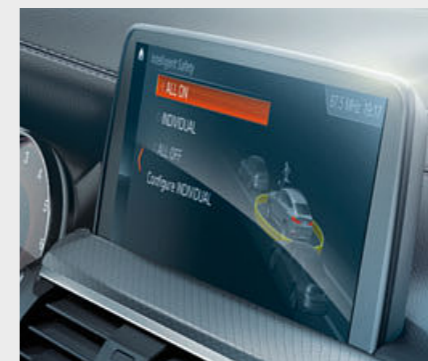

20 Driver assistance
21 Safety



22 Connectivity and infotainment
23 Comfort and functionality

EQUIPMENT.



24 Models and Lines



30 BMW Individual



32 Equipment highlights

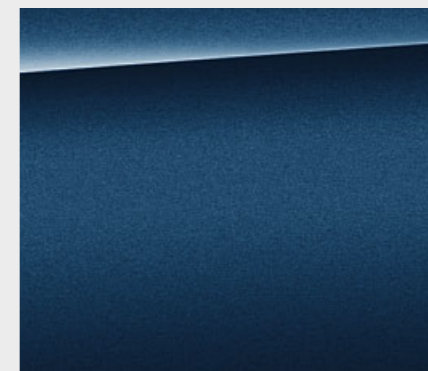

36 Exterior colour world

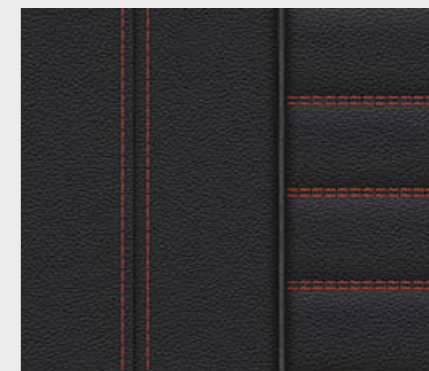

38 Interior colour world



40 Wheels and tyres



41 Original BMW Accessories

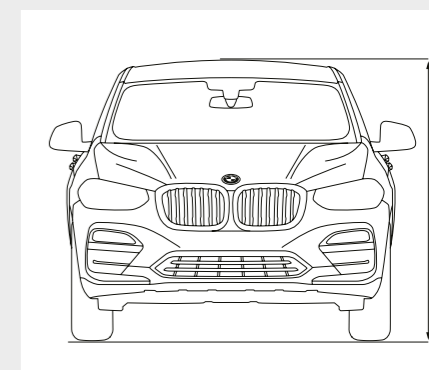

42 Technical data

**DYNAMICS
xDESIGN.**



**FULL FORCE
AHEAD.**





**HIGH DESIGN,
HIGH SPEED.**





**PLACE OF RETREAT
FOR EXTROVERTS.**



**FINALLY SOMEONE
WHO UNDERSTANDS YOU.**





**THE MOST
BEAUTIFUL PLACE
IN TOWN.**

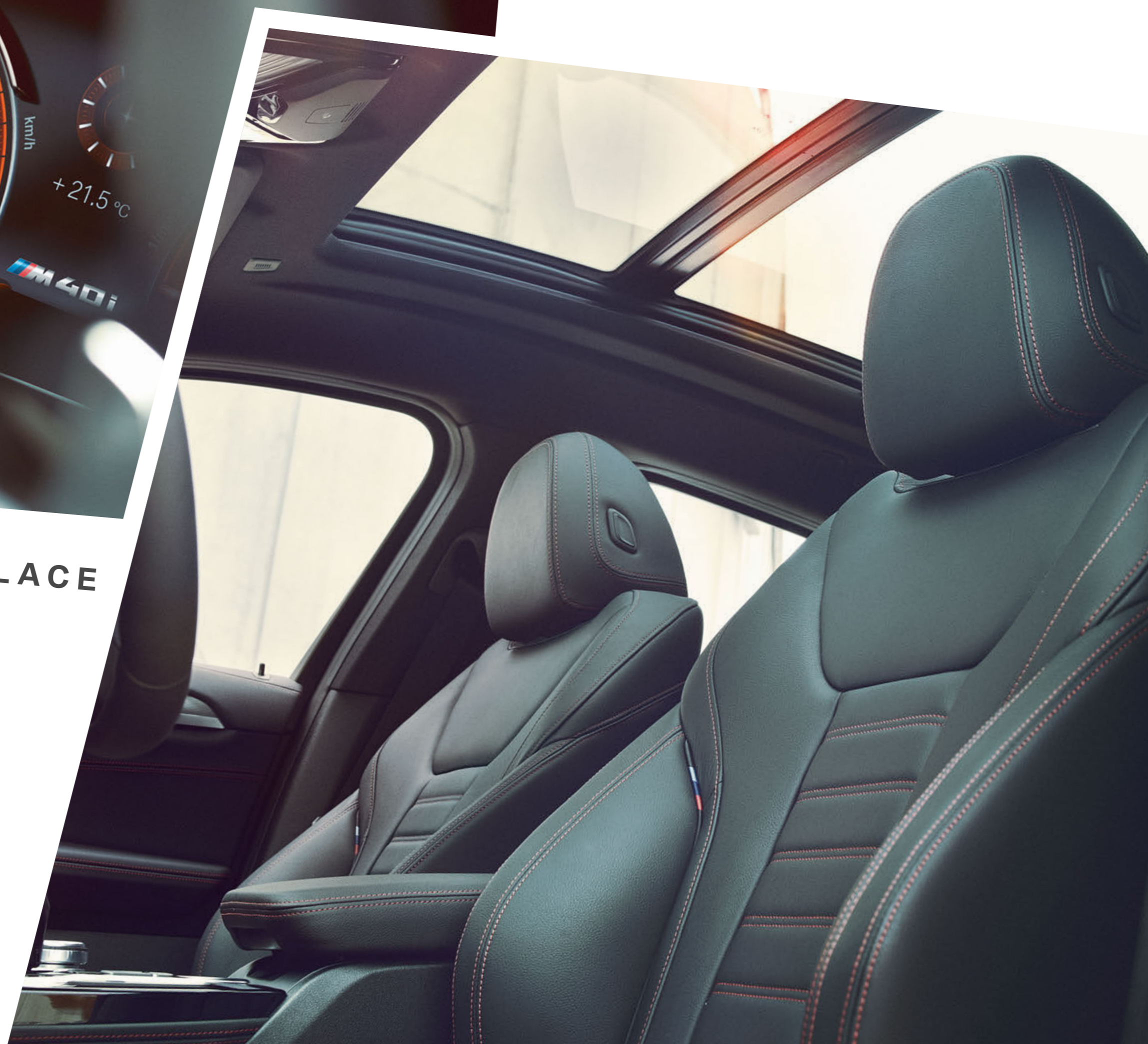



**BRING IT ON.
THE NEW BMW X4.**

SELF-ASSURED ATHLETIC EXTERIOR DESIGN SPORTY SILHOUETTE AND AERODYNAMIC KIDNEY GRILLE || FULL-LED FRONT HEADLIGHTS AND REAR LIGHTS || 21" LIGHT ALLOY WHEELS.¹ **BRILLIANT PERFORMANCE** 50:50 WEIGHT DISTRIBUTION FOR IDEAL AGILITY || BMW xDRIVE WITH ACTIVE M SPORT DIFFERENTIAL¹ || M PERFORMANCE FOR MORE ATHLETICISM. **INNOVATIVE ASSISTANCE SYSTEMS** DRIVING ASSISTANT PLUS || STEERING AND LANE CONTROL ASSISTANT^{1,2} || CROSSROADS WARNING^{1,2} || PARKING ASSISTANT PLUS.¹ **EASY CONNECTIVITY** 10.25" CONTROL DISPLAY WITH TOUCH CONTROL^{1,3} || GESTURE CONTROL¹ || BMW HEAD-UP DISPLAY¹ || BMW CONNECTED^{1,4} AND CONCIERGE SERVICE^{1,4}. **UNMISTAKABLY AESTHETIC INTERIOR DESIGN** LARGE PANORAMA GLASS ROOF¹ || AMBIENT LIGHT IN THE INTERIOR AND EXTERIOR WITH WELCOME LIGHT CARPET¹ || UNIQUE DESIGN OPTIONS BY BMW INDIVIDUAL. **EXPERIENCE ITS ATHLETICISM, DISCOVER ITS AESTHETICS. THE NEW BMW X4.**

¹ Available as optional equipment.
² Part of the Driving Assistant Plus package.
³ Part of Navigation system Professional.
⁴ Requires BMW ConnectedDrive Services.

Some ConnectedDrive Services may differ between countries. Please consult your local BMW partner for more information.

DYNAMICS AND EFFICIENCY.

BMW EFFICIENT DYNAMICS.
LESS EMISSIONS. MORE DRIVING PLEASURE.

MORE POWER FROM LESS FUEL.

More power from three to 12 cylinders. Consume less, experience more – the **BMW TwinPower Turbo engines** offer the greatest possible dynamic performance with the highest efficiency thanks to the latest injection systems, variable output control and sophisticated turbocharger technology. Whether diesel or petrol, and no matter how many cylinders, the engines from the BMW EfficientDynamics engine family allow markedly more agile power delivery and outstanding responsiveness even at low rpm, while being fuel-efficient and low in emissions.

MORE DRIVING PLEASURE, LESS EMISSIONS.

Approximately 33% less CO₂ emissions since 2000: **BMW EfficientDynamics** is a technology package that includes not only the drive, but rather the whole vehicle concept and intelligent energy management. Provided as standard in every BMW, a variety of innovative technologies contribute to continuously improving efficiency. Via engine efficiency measures, electrification, lightweight construction methods and optimised aerodynamics, BMW has managed to reduce the CO₂ emissions of its fleet by 33%.

MORE SPEED, LESS WEIGHT.

Lower weight with intelligent lightweight construction. Special consideration for every last detail – intelligent lightweight construction means that the optimal material is found and implemented for each part of the vehicle. With extremely light high-tech materials such as aluminium and carbon fibre, **BMW EfficientLightweight** is pursuing the goal of minimising vehicle weight. That leads to even more dynamic performance, increased stability and heightened vehicle safety and comfort.



AERODYNAMICS

With targeted measures focusing on aerodynamics, BMW has optimised the drag coefficient and efficiency as well as interior acoustics. Fuel consumption has also been reduced. The Active air stream kidney grille and the Air Curtain on the front wheels are targeted detailed measures to further reduce air resistance.

ACTIVE AIR STREAM KIDNEY GRILLE

The Active air stream kidney grille represents the cutting edge of aerodynamic performance. When a cooling airflow is not needed, it electronically closes the radiator grille with its air vents and thereby reduces the amount of air flowing into the engine bay. This optimises both the aerodynamics and consumption rates.

DRIVING EXPERIENCE CONTROL INCL. ADAPTIVE MODE

The Driving Experience Control offers the driver the choice between the standard COMFORT mode, ECO PRO Mode, geared towards efficiency, and SPORT mode, which enables even more dynamic driving. The new interactive function ADAPTIVE Mode¹ continuously adjusts the Dynamic Damper Control, the steering and the Steptronic transmission to suit the current driving situation.

IN THE NEW BMW X4.

¹ Only available in conjunction with a navigation system.

DRIVETRAIN AND SUSPENSION.



ENGINE HIGHLIGHTS OF THE NEW BMW X4.

M40d xDrive

BMW TwinPower Turbo 6-cylinder diesel engine with 240 kW (326 hp) and 680 Nm torque
Acceleration 0–100 km/h: 4.9 s
top speed: 250 km/h
Combined fuel consumption: 6.4–6.6 l/100 km
Combined CO₂ emissions: 170–173 g/km

M40i xDrive*

BMW TwinPower Turbo 6-cylinder petrol engine with 260 kW (354 hp) and 500 Nm torque
Acceleration 0–100 km/h: 4.8 s
top speed: 250 km/h
Combined fuel consumption: 9.0–9.2 l/100 km
Combined CO₂ emissions: 209–213 g/km

WE KEEP OUR PROMISE: AS STANDARD, ALL BMW TWIN POWER TURBO ENGINES CONFORM TO THE EU6 STANDARD THANKS TO BMW EFFICIENT DYNAMICS.

The **8-speed Steptronic Sport transmission**¹ offers incredibly sporty gear changes. Whether automatic or manual using gearshift paddles or gear lever – for comfortable coasting or incredibly dynamic driving. In SPORT mode and with the gear lever in the left-hand S/M position, the gear shifts are configured for maximum performance.

The intelligent **BMW xDrive all-wheel** drive system smoothly and variably distributes drive power to the front and rear wheels for maximum traction, driving dynamics and safety in every driving situation. For even better agility, the electronically controlled power distribution for instance counterbalances oversteer or understeer on bends.

The **Adaptive M suspension**^{2,3} can be electronically adjusted at any time to suit the road and driving conditions. The driver can also adjust the suspension characteristics via the Driving Experience Control to enable their preferred driving style at the time – from comfortable to extremely athletic with markedly agile handling.

The **adaptive suspension**^{2,4} makes it possible to adjust the damper characteristics to suit any given driving situation, increasing comfort and driving dynamics. In addition to the standard COMFORT setting, for high driving comfort, there are two other programs available, SPORT and SPORT+, for an even sportier driving style.

Performance Control intervenes via engine control and through controlled braking of the drive wheels towards the inside of the bend. This distributes more drive power to the outer wheels. Directing the vehicle's angular momentum into the curve to boost agility and directional stability.

Dynamic Stability Control (DSC) permanently assesses the vehicle's movements and stabilises it using engine and braking regulation when unstable driving conditions are detected. Additional features of DSC are, for example, brake drying, braking readiness or the Hill-Start assistant, which holds the vehicle briefly in place when starting on inclines to prevent it from rolling backwards.

¹ Standard for xDrive30i, xDrive30d, M40i, xDrive25d and M40d.

² Available as optional equipment.

³ Only available for M40i and M40d.

⁴ Only available for xDrive20i, xDrive30i, xDrive20d, xDrive25d and xDrive30d.

Performance, fuel consumption and CO₂ emissions figures refer to vehicles with standard transmission. Further information on fuel consumption and CO₂ emissions can be found in technical data or consult your local BMW partner.

* Available from 08/18. Provisional figures. Any missing figures were unavailable at the time of publication.

DRIVER ASSISTANCE.

BMW Personal CoPilot By your side, when you decide.



Driving Assistant Plus^{1,2,3} offers greater comfort and security during monotonous or complex driving situations. These can include traffic jams, stop-and-go traffic or long journeys through the city, on country roads or motorways, along with navigating junctions and lane changes.

The **Steering and lane control assistant incl. Traffic jam assistant^{1,4}** can be activated to support you in monotonous traffic situations. At speeds of up to 210 km/h on all road surfaces, the system conveniently supports steering and keeps the vehicle in the centre of its lane. Steering support is possible with or without Active cruise control.

When approaching crossroads with traffic lights, a give-way sign or a stop sign, the **Crossroads Warning^{1,4}** recognises any traffic signs and warns the driver with acoustic and visual signals. Additionally, the brakes are prepared, ensuring that maximum braking power is immediately available.

The **Lane keeping assistant with active side collision protection^{1,4}** assists the driver at speeds between 70 km/h to 210 km/h with convenient corrective steering interventions, helping to keep the vehicle in the lane and to actively avoid potential side impacts.

Evasion assist^{1,4} supports the driver with a targeted steering intervention at speeds of between 40 and 160 km/h when an obstacle must be avoided. Furthermore, the system helps the driver to keep the vehicle stable during the evasive manoeuvre.

Active cruise control¹ with Stop&Go function, Speed Limit Info including No-overtaking indicator and Approach control warning with braking function reacts to stationary vehicles, independently maintains a preselected distance from the vehicle ahead and controls speed down to standstill, automatically accelerating again as soon as traffic flow allows it.

The equipment package **Parking Assistant Plus^{1,5}** makes parking and manoeuvring the vehicle easier. It features Surround View including Top View, Remote 3D View, PDC as well as a lateral parking aid, the Active Park Distance Control (PDC), emergency braking function and the Parking Assistant with linear guidance that provides fully automatic parking both parallel and perpendicular to the road.

SAFETY.

■ Standard equipment □ Optional equipment

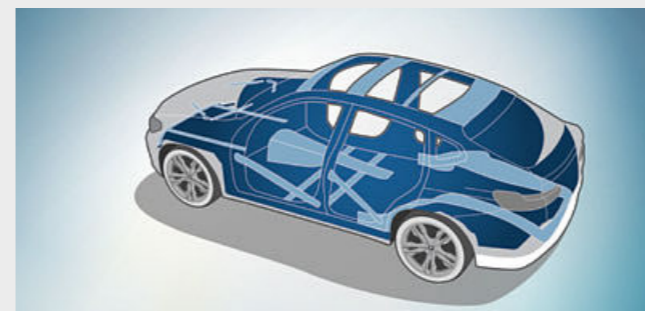

■ The functional structure of the **passenger cell** is composed of a specialised system of beams and nodal connections, featuring strategically deployed high-strength materials so as to deliver maximum passive safety in the event of front, side and rear collisions.

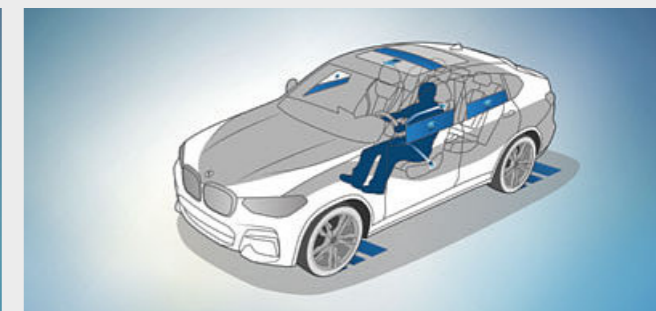

□ **Active Protection** is the BMW ConnectedDrive preventive passenger protection system. Active Protection warns the driver if it detects signs of tiredness, safety belts are pretensioned in critical situations, electric seats are returned to upright positions and the windows and sliding roof are closed. After an accident occurs, the brakes are automatically applied until the car reaches a standstill.

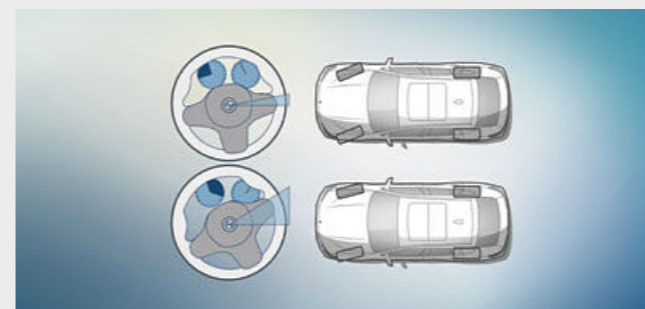

■ The **Variable sport steering** with Servotronic creates a direct and agile steering response and ensures that less physical effort is required to turn the wheel. It reacts to the angle of the steering wheel with varying steering ratios. This improves handling when driving more dynamically and reduces the effort needed to steer when parking and turning.

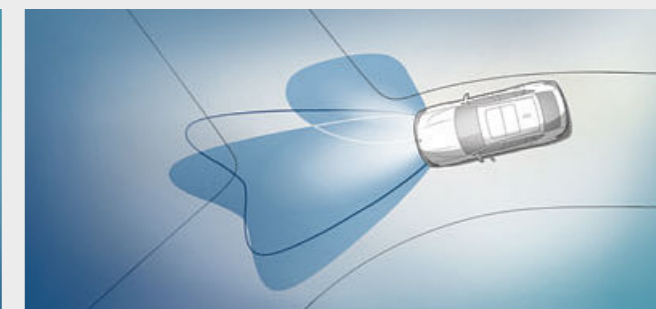

□ The **adaptive LED headlights** include low-beam and anti-dazzle high-beam headlights (BMW Selective Beam) and turn indicators with full LED technology. The equipment also features cornering lights, daytime running lights and Adaptive headlights with variable light control for excellent illumination of the road ahead and better visibility in the dark.

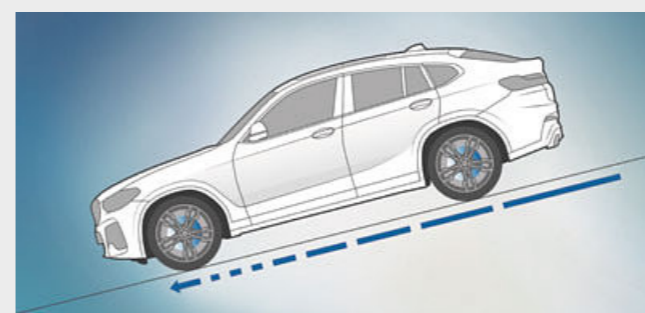

■ The optional **Hill Descent Control (HDC)** in the xDrive models is a system which, when activated, ensures that the vehicle can master the steepest downhill runs automatically and safely at just above walking pace, without the driver having to brake.

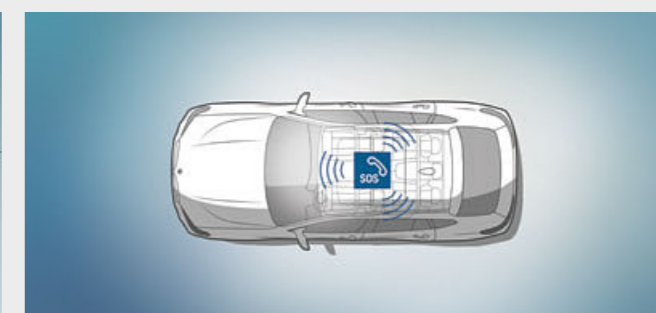

□ The **Intelligent Emergency Call** automatically establishes a connection with the nearest rescue coordination centre through the BMW call centre whenever needed – without the use of a mobile phone. It transmits information regarding the vehicle's current location and the severity of the accident. The Intelligent Emergency Call can also be triggered manually in case other road users require help, for example.

¹ Available as optional equipment.

² Only available in conjunction with interior and exterior mirror package.

³ Function may be limited in darkness, fog or bright glare.

⁴ Part of the Driving Assistant Plus package.

⁵ Only available in conjunction with the Professional Navigation system.

CONNECTIVITY AND INFOTAINMENT.

BMW ConnectedDrive Connected to be free.

CONNECTED
FOR OVER **40** YEARS.

Focused on the future – from the very beginning. By the 1970s, BMW had already made headway in connected mobility. Another milestone of the digital future was surpassed in 1999: vehicles with built-in SIM cards. Then came the first online functionality, Google Services and innovative display systems such as the BMW Head-Up Display. Throughout this process, the desires of the customer have always taken centre stage. In a first for a premium automobile manufacturer, BMW makes it possible to book and pay for services flexibly via the BMW ConnectedDrive Store, in the vehicle or on a computer at home. And with the introduction of BMW Connected and the Open Mobility Cloud, BMW is taking the next steps into the future of mobility.

MORE THAN **20** SERVICES
IN THE BMW CONNECTED DRIVE STORE.

The ConnectedDrive Services equipment forms the basis for intelligent BMW ConnectedDrive functions. This equipment also provides access to the BMW ConnectedDrive Store, in which services can be ordered and extended easily, any time and anywhere to suit the user's individual requirements – for example with the Concierge Service or Connected Music, which turn every drive into a convenient and entertaining experience.

IN TOUCH **24/7**
WITH BMW CONNECTED.

What would it be like if you were never late again? What if your BMW already knew your preferred destinations? How would you like reliable navigation, whether you're sitting in your vehicle or not? BMW Connected provides you with the information you want, when and where you want it. BMW Connected is a personal mobility assistant which facilitates your everyday mobility and aids you in reaching your destinations relaxed and on time. With the BMW Connected app, mobility-relevant information such as recommendations for optimal departure times are available at any time via smartphone or smartwatch and can be seamlessly transmitted to the car.



BMW CONNECTED+

BMW Connected+ provides a more extensive level of integration of the BMW Connected app^{1,2} in your BMW. You can enjoy seamless connectivity between all BMW Connected touchpoints and your BMW and thus benefit from the personalised services supported by the BMW Open Mobility Cloud.

WiFi HOTSPOT

The equipment includes a built-in WiFi hotspot^{1,3} using the LTE standard, which allows for a paid Internet connection. The vehicle is connected via the built-in SIM card with a fee-based hotspot plan from a service provider.

CONCIERGE SERVICE

Concierge Service^{1,2} puts the driver through to a BMW Call Centre employee at the touch of a button. The employee can locate a particular restaurant, the closest cash dispenser or an emergency pharmacy and send the address details directly to the car's BMW navigation system.

IN THE NEW BMW X4.

¹ Available as optional equipment.
² Only available in conjunction with ConnectedDrive Services.

³ The WiFi hotspot enables in-vehicle use of the internet with the maximum LTE standard. Use is subject to cost.

COMFORT AND FUNCTIONALITY.



In warm weather, the **Active seat ventilation**^{1,2}, front provides a cool and pleasant seat temperature, resulting in a more comfortable driving experience. Air vents in the seat surfaces and backrests blow air through the perforated seat covers. The intensity of the airflow is selected from three available settings.

The **acoustic glazing**¹ on the front side windows complements the acoustic glazing on the front windscreen and significantly reduces the level of noise for everyone inside the vehicle. It minimises noise created by the outside surroundings and flow of air, as well as by the engine, tyres and windscreen wipers. Music listeners and hands-free device users in particular will appreciate the difference this makes.

When open, the **Panorama glass roof**¹ provides a great deal of fresh air. Closed, it creates a bright, light-flooded atmosphere in the interior. It opens and closes completely automatically at the push of a button, or remotely, and is equipped with slide and lift functions, roller sunblind and wind deflector.

The **Comfort access system**¹ makes it possible to open all four vehicle doors, including the luggage compartment, without using the key. This equipment option includes contactless opening and closing of the tailgate with a quick wave of the foot under the rear bumper.

Ambient light, including Ambient contour lighting¹ in the front and rear doors, creates a relaxed, cosy lighting atmosphere in the interior. The **Welcome Light Carpet**^{1,3} illuminates the area in front of the car doors when entering and exiting. Six dimmable light designs in White, Blue, Orange, Bronze, Lilac and Green are available.

The **Storage compartment package**¹ includes a hinged compartment in the front, nets on the back of the front seats, 12 V sockets in the rear centre console incl. USB adapter. The luggage compartment also contains hooks on the luggage compartment wall, a fastening strap, lashing rails on the luggage compartment floor and adjustable fastening points, a remote backrest unlocking and a cargo function for expanding the luggage compartment volume.

¹ Available as optional equipment.

² Only available in conjunction with Automatic air conditioning with three-zone control.

³ Part of the Ambient light equipment.

Some ConnectedDrive Services may differ between countries. Please consult your local BMW partner for more information.

BASIS.

Discover more with the new BMW catalogue app. Now available for your smartphone and tablet.

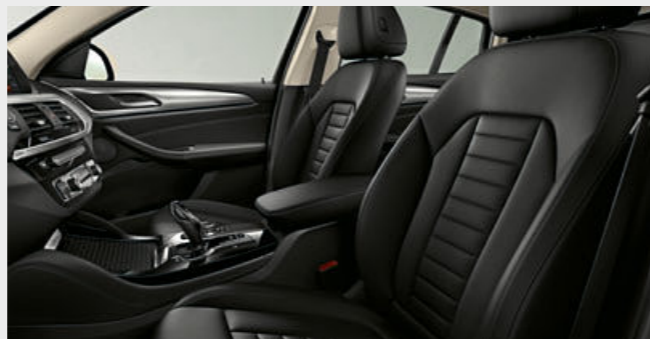

■ The slim-line modelled instrument panel provides a distinctly noticeable command position that gives optimal overview of the action at all times. The interior trim finishers in Oxide Silver dark matt with highlight trim finishers Pearl Chrome provide visual highlights.

□ At first glance, the ergonomically perfectly designed driving experience area shows BMW's typical orientation towards the driver. The standard seats have multiple manual adjustment options, ensuring a particularly good seating position and optimum lateral support. Finished as standard in Cloth 'Hevelius' Anthracite and interior colour black with many optional choices such as the high-quality leather 'Vernasca' or BMW Individual extended leather trim 'Merino'.

Selected base model equipment features:

- 18" light alloy wheels V-spoke style 618
- LED headlights
- Sport leather steering wheel
- 1-zone automatic air conditioning
- BMW Professional radio with 6.5" LCD colour display
- Driving Experience Control
- M Sport suspension
- Variable sport steering
- Performance Control
- Cruise Control with braking function
- Park Distance Control (PDC), rear



□ 18" light alloy wheels Double-spoke style 688 Reflex Silver, wheel size 7J x 18 with 225/60 R18 tyres.



□ 19" light alloy wheels V-spoke style 691 in Reflex Silver, wheel size 7.5J x 19 with 245/50 R19 tyres.

xLINE.

■ Standard equipment □ Optional equipment

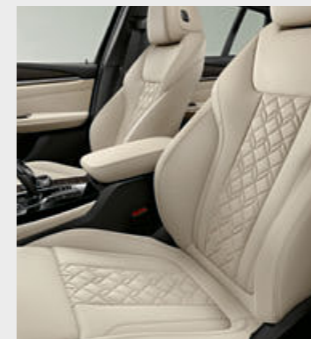

□ The combination of the Sport leather steering wheel with the optional fine-wood trim 'Fineline' Cove highlight trim finisher in Pearl Chrome has a sporty and elegant effect.

□ Sport seats with pronounced side bolsters in BMW Individual extended 'Merino' leather Ivory White lend the interior a highly elegant look.



■ 19" light alloy wheels Y-spoke style 694, Ferric Grey, wheel size 7.5J x 19 with 245/50 R19 tyres.

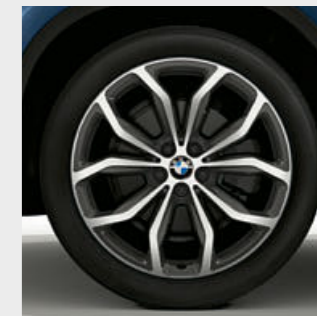

□ 20" light alloy wheels Y-spoke style 695 Orbit Grey bright turned with mixed tyres, front 8J x 20 with 245/45 R20 tyres, rear 9.5J x 20 with 275/40 R20 tyres.

xLine exterior equipment:

- BMW kidney grille with seven exclusively designed vertical slats with front sides in Aluminium matt, grille frame in Chrome
- 19" light alloy wheels Y-spoke style 694 in Ferric Grey; other wheels available
- Air Breather in Pearl Chrome
- Side window surrounds, window guides and window recess finisher in Aluminium satinised, mirror foot, B-pillar and C-pillar in Black high-gloss
- Side skirt trim in Aluminium matt
- Underbody protection front and rear in Aluminium matt

xLine interior equipment:

- Door sill finishers in Aluminium with "BMW xLine" lettering
- Sport seats for driver and front passenger in Cloth/leather combination 'Vivus' Anthracite with contrast stitching; other upholsteries available
- Car key with Chrome high-gloss detailing
- Interior trim finishers in Black high-gloss with accent in Pearl Chrome; other trims available

M SPORT PACKAGE.

powered by 

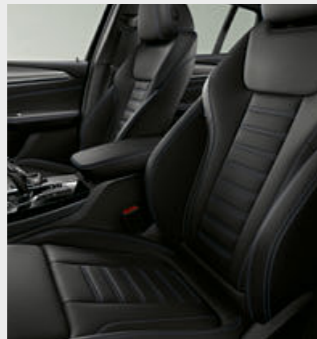

■ High-quality and high-grip M leather steering wheel with multifunction buttons.

□ The sport seats in leather 'Vernasca' Black with contrast stitching in blue underline the sporty atmosphere.

■ 19" M light alloy wheels Double-spoke style 698 M in Bicolour Ferric Grey, bright turned, wheel size 7.5J x 19 with 245/50 R19 tyres.

□ 20" M light alloy wheels Double-spoke style 699 M in Bicolor Orbit Grey, bright turned, with mixed tyres, front 8J x 20 with 245/45 R20 tyres, rear 9.5J x 20 with 275/40 R20 tyres.

M Sport package exterior equipment:

- M Aerodynamics package with front apron, side skirts and wheel arch trims in body colour
- LED fog lights
- 19" M light alloy wheels Double-spoke style 698 M in Bicolor Ferric Grey gloss-lathed with run-flat properties; other wheels available
- M Sport suspension
- BMW Individual high-gloss Shadow Line, alternatively BMW Individual Exterior Line Aluminium satinised
- M designation on the sides
- Exterior mirror caps in body colour
- M Sport brake
- Rear apron with diffuser insert in Dark Shadow metallic
- Tailpipe trim strip in high-gloss Chrome
- Exclusive paintwork in Carbon Black metallic; other paintworks available

M Sport package interior equipment:

- M door sill finishers, M driver footrest and M specific pedals
- Sport seats for driver and front passenger in Cloth/leather combination 'Vernasca' Black with contrast stitching in blue or red, alternatively
- Sport seats for driver and front passenger in Exclusive leather 'Vernasca' Black with contrast stitching in blue or red featuring instrument panel in Sensatec with blue or red stitching; other upholsteries available
- M Leather steering wheel with Multifunction
- BMW Individual headliner anthracite
- Interior trim finishers in Aluminium Rhombic with highlight trim finishers in Pearl Chrome, other trims available
- Car key with exclusive M designation
- M specific floor mats in velour
- Loading sill of the luggage compartment in stainless steel

M SPORT X PACKAGE.

Equipment 26 | 27

powered by 

■ Standard equipment □ Optional equipment

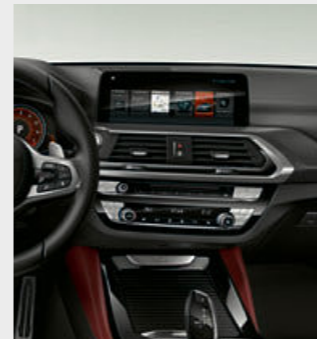

■ The interior trim finishers Aluminium Rhombic dark with highlight trim finishers Pearl Chrome are exclusively available for the M Sport X package and further emphasise the sporty, distinctive interior design.

□ The Sport seats in optional leather 'Vernasca' Tacora red with contrast stitching in basalt grey provide a high-quality ambience and high seating comfort even during long journeys.

■ 19" M light alloy wheels Double-spoke style 698 M in Bicolour Ferric Grey, bright turned, wheel size 7.5J x 19 with 245/50 R19 tyres.

□ 20" M light alloy wheels Double-spoke style 787 M in Bicolor Orbit Grey, bright turned, with mixed tyres, front 8J x 20 with 245/45 R20 tyres, rear 9.5J x 20 with 275/40 R20 tyres.

M Sport X package exterior equipment:

- M Sport X exterior package with side skirts, wheel arch trim and rear apron with diffuser insert in Frozen Grey
- M Aerodynamics package with front apron in body colour
- LED fog lights
- 19" M light alloy wheels Double-spoke style 698 M in Bicolor Ferric Grey gloss-lathed with run-flat properties; other wheels available
- M Sport suspension
- BMW Individual high-gloss Shadow Line
- M designation on the sides
- Exterior mirror caps in body colour
- M Sport brake
- Tailpipe trim strip in high-gloss Chrome
- Exclusive paintwork in Carbon Black metallic; other paintworks available

M Sport X package interior equipment:

- M door sill finishers, M driver footrest and M specific pedals
- Sport seats for driver and front passenger in Cloth/leather combination 'Vernasca' Black with contrast stitching in blue or red, alternatively
- Sport seats for driver and front passenger in Exclusive leather 'Vernasca' Black with contrast stitching in blue or red featuring instrument panel in Sensatec with blue or red stitching; other upholsteries available
- M Leather steering wheel with Multifunction
- BMW Individual headliner anthracite
- Exclusive interior trim finishers in Aluminium Dark Rhombic with highlight trim finishers in Pearl Chrome, other trims available
- Car key with exclusive M designation
- M specific floor mats in velour
- Loading sill of the luggage compartment in stainless steel

BMW M PERFORMANCE.

The new BMW X4 M40i.

The **BMW X4 M40i** offers outstanding precision and agility. The dynamic lateral and longitudinal characteristics are increased, and intensive driving pleasure assured, thanks to the comprehensive new calibration of the suspension, the M Performance-specific calibration of the variable sport steering, the standard M Sport brake and a BMW xDrive all-wheel drive system with emphasis on the rear wheels incl. M Sport differential.



M PERFORMANCE



The 8-speed Steptronic Sport transmission offers incredibly sporty gear changes. Whether automatic or manual using gearshift paddles or gear lever – for comfortable coasting or incredibly dynamic driving. In SPORT mode and with the gear lever in the left-hand S/M position, the gear shifts are configured for maximum performance.



Also no compromise inside: the M leather steering wheel with shift paddles and the M-specific pedals combine sporting form and function.



The aluminium front doorsill finishers welcome the driver and front passenger with the "M40i" high-quality model designation.



The M Aerodynamics package underscores the vehicle's imposing athleticism and optimizes its airflow. The front and rear feature distinctive bumpers in body colour. The special side skirts are also finished in body colour and emphasise the athletic appearance. The colour-contrasting rear diffuser insert in Dark Shadow metallic is an eye-catching feature on the rear.



BMW Individual paint finish Sunstone metallic and 21" BMW Individual light alloy wheels V-spoke style 726 I.

BMW Individual doorsill finishers¹ with BMW Individual designation.



BMW INDIVIDUAL.

The expression of personality.

The BMW Individual Collection offers an exclusive selection of equipment options to meet each and every wish for your new BMW X4.

The new BMW Individual paint finish Sunstone metallic captivates with its brilliance of colour and the way it shimmers between silver and nuances of gold. The finish also perfectly accentuates the elegant silhouette of the new BMW X4. The exclusive 21" BMW Individual light alloy wheels V-spoke style 726 I, meanwhile, underscore the powerful athleticism of the vehicle.

Inside, the BMW Individual extended fine-grain Merino leather trims in Fiona Red/Black, Ivory White or Tartufo create a uniquely spacious feel. The interior trim finishers in Piano finish Black create an elegant impression. BMW Individual headliner in Anthracite and characteristic doorsill finishers are additional appealing highlights.



BMW Individual interior trim Piano finish Black.

BMW Individual extended fine-grain 'Merino' leather in Ivory White, BMW Individual interior trim finishers Piano finish Black and BMW Individual headliner in Anthracite.



EXPERIENCE BMW INDIVIDUAL INTERACTIVE WITH THE BMW INDIVIDUAL APP FROM THE APP STORE AND THE GOOGLE PLAY STORE.

¹ BMW Individual doorsill finishers not in conjunction with M Sport package and M Performance automobiles.

EQUIPMENT HIGHLIGHTS.

Discover more with the new BMW catalogue app. Now available for your smartphone and tablet.

■ Standard equipment □ Optional equipment



□ When open, the Panorama glass roof provides a great deal of fresh air. Closed, it creates a bright, light-flooded atmosphere in the interior. It opens and closes completely automatically at the push of a button, or remotely, and is equipped with slide and lift functions, roller sunblind and wind deflector.



□ The individually adjustable Sport seats for the driver and front passenger feature numerous manual adjustment options, including backrest width, fore-and-aft position, and the backrest and seat angle. Thanks to taller seat and backrest bolsters, and well-defined side bolsters, they provide excellent ergonomics and a high degree of lateral support.



□ The BMW Individual extended fine-grain 'Merino' leather in Ivory White impresses with the outstanding quality of the hide, as well as with masterfully crafted details.



■ The slight tinted heat/sun protection glazing reflects infrared radiation to prevent the interior from heating up.
□ The acoustic glazing on the front side windows complements the acoustic glazing on the front windscreen and reduces the level of noise for everyone inside the vehicle.



□ In warm weather, the Active seat ventilation¹, front provides a cool and pleasant seat temperature, resulting in a more comfortable driving experience.



□ The full-colour BMW Head-Up Display² projects all information relevant to the journey directly into the driver's field of vision.



□ Exclusive galvanic embellishers for controls such as the Start/Stop button, along with volume and temperature dials, lend a particularly high-quality look.



□ The Instrument panel and door panels in Sensatec lend the interior of the vehicle a highly exclusive atmosphere.



□ Harman Kardon surround sound system³ with 600 watt digital amplifier, vehicle-specific equalising and loudspeakers with chrome detailing.



□ Remote backrest unlocking⁴ for the rear seats allows the rear seat backrests to be unlocked and folded down conveniently via a lever in the luggage compartment.



□ The Roof rails in Aluminium satinated provide the base for a multifunctional BMW roof rack unit.



□ The Trailer tow hitch with electrically adjustable tow ball and trailer stability control is approved for heavy loads of up to 2,400 kg.



■ The rear lights with lighting elements in LED technology consist of individual high-performance LED lighting elements and have the characteristic, striking BMW L-shape, meaning that the vehicle is clearly recognisable as a BMW even in the dark.



□ The 8-speed Steptronic Sport transmission⁵ offers incredibly sporty gear changes. Whether automatic or manual using gearshift paddles or gear lever.



■ The Storage options, including the storage compartment, encompass several storage spaces, including bottle holders and cupholders.

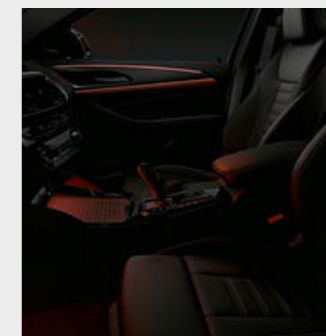

□ Ambient light creates a relaxed lighting atmosphere, including ambient light accents and the Welcome Light Carpet.

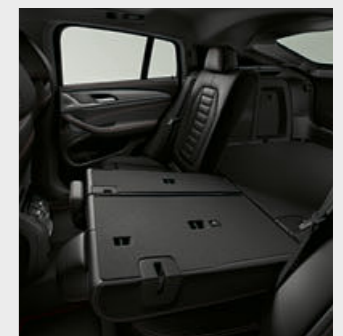

■ The Through-loading system with rear seat backrests, which are divisible in a 40:20:40 ratio, guarantees flexibility when transporting people and objects.

¹ Only available in conjunction with Automatic air conditioning with three-zone control.

²The information in the BMW Head-Up Display is not fully visible when viewed through polarised sunglasses. Content shown will depend on the equipment options chosen. Further optional equipment is required to display specific items.

³ Only available in conjunction with the Professional Navigation system.

⁴ Part of the Storage compartment package.

⁵ Standard for xDrive30i, M40i, xDrive25d and M40d.

EQUIPMENT HIGHLIGHTS.

Discover more with the new BMW catalogue app. Now available for your smartphone and tablet.

■ Standard equipment □ Optional equipment



□ With BMW Gesture Control¹, certain functions can be operated by means of defined hand movements. For certain operations the system will for example recognise gestures such as 'swiping' or 'pointing' for accepting or rejecting an incoming call, or circular motions of the index finger to adjust volume.



□ The Navigation system Professional incl. 10.25" LCD colour display and Radio BMW Professional with DVD drive comes with more than 20 GB of memory e.g. for audio files. It is operated intuitively via the iDrive Touch Controller and seven functional bookmarks or alternatively via the Touch Display.

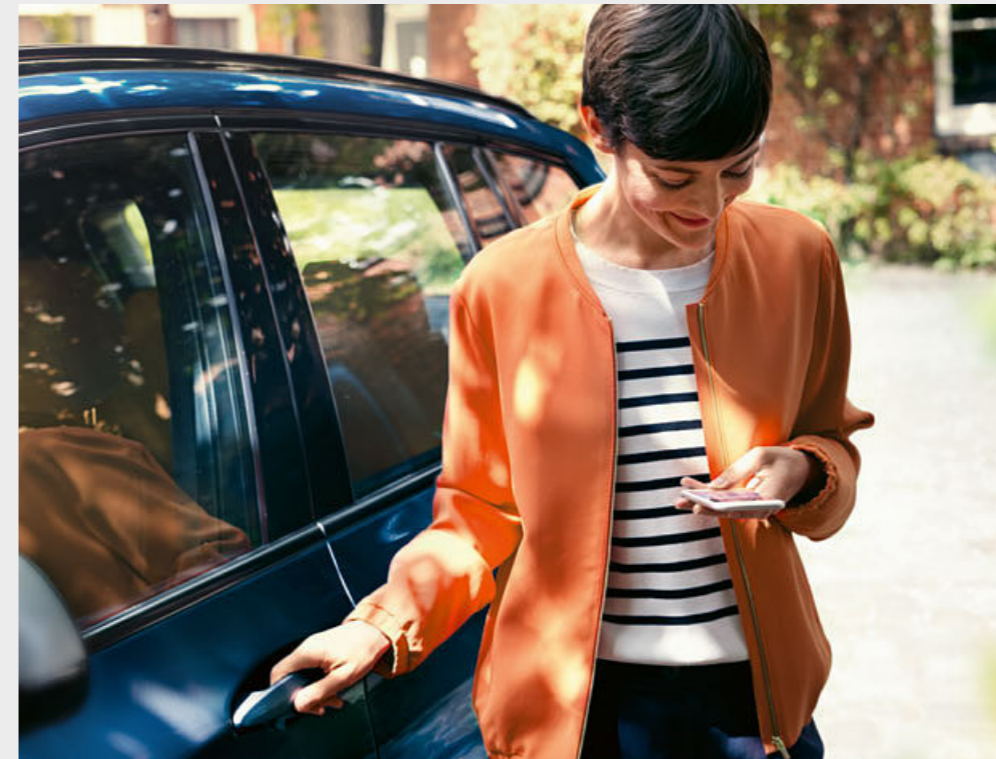

□ BMW Connected+⁶ delivers a more seamless level of integration in your BMW and now offers an even larger selection of personalised services.

□ Upon arrival, you can use the "Door-to-door navigation"⁸ function⁸ to be guided from your parked car to your final destination by foot.



□ Telephony with wireless charging² offers a comprehensive telephony package with Bluetooth connectivity and the technical capacity for a WiFi hotspot.

□ The equipment includes a built-in WiFi hotspot³ using the LTE standard, which allows for a paid Internet connection.



□ The Multifunctional instrument display¹ with Black Panel technology and a screen diagonal of 12.3" provides a highly impressive visualisation of the driving experience. Three different modes and their specific displays – each of them have their own colour scheme and graphic style – can be displayed in the instrument cluster: ECO PRO, COMFORT and SPORT.

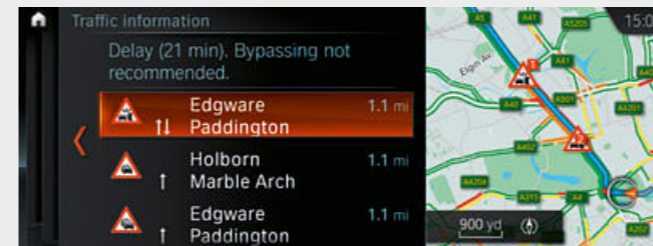

□ Real Time Traffic Information (RTTI)^{7,8} from BMW ConnectedDrive has been enhanced with a new function, the hazard alert, which allows vehicles to warn one another of hazards detected by the vehicle sensors, such as an accident or heavy rain along the route. Notifications of such hazards are displayed on the map in the vehicle display.

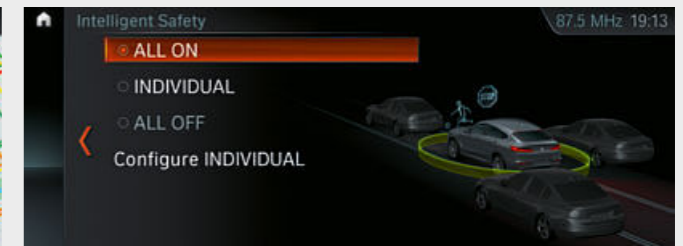

□ Driving Assistant Plus⁹ offers greater comfort and security during monotonous or complex driving situations. These can include traffic jams, stop-and-go traffic or long journeys through the city, on country roads or motorways, along with navigating junctions and lane changes.



□ The BMW display key shows various information about the vehicle's status and allows selected functions to be controlled with an integrated touch display.



□ The Ambient Air Package comprises a fragrance dispersal function and an air ionisation function.

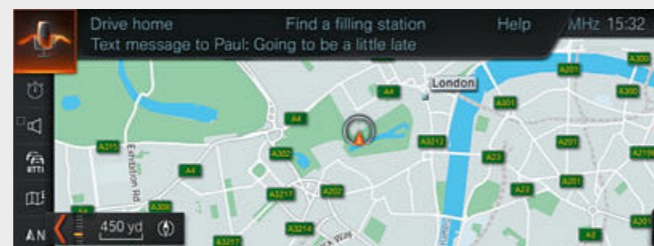

□ Intelligent Voice Assistant^{4,5} understands natural speech and optimises recognition rate over a large range of individual and situational variations thanks to Offboard⁵ voice processing. It also understands linguistic varieties, dialects and jargon. This enables a substantially greater range of possibilities when dictating text messages or emails.

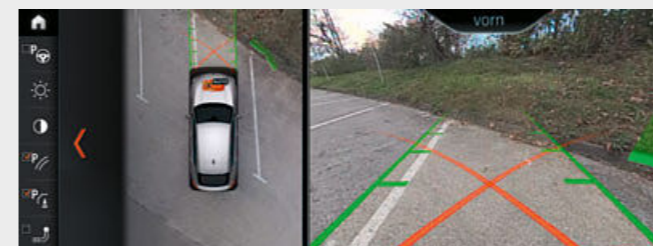

□ The equipment package Parking Assistant Plus¹ makes parking and manoeuvring the vehicle easier. It features Surround View including Top View, Remote 3D View, PDC as well as a lateral parking aid, the Active Park Distance Control (PDC), emergency braking function and the Parking Assistant with linear guidance that provides fully automatic parking both parallel and perpendicular to the road.



□ Surround View⁹ includes the camera-based functions Rear view camera, Top View, Panorama View, 3D View and Remote 3D View¹⁰. The cameras in the exterior mirrors as well as at the front and rear allow for a 360° all-around view. The Panorama View makes approaching intersections and exiting driveways safer. It shows the traffic to the right and left of the car on the Control Display.

¹ Only available in conjunction with the Professional Navigation system.
² Inductive charging for Qi-compatible mobile phones is possible. Special charging cases are available from Original BMW Accessories for selected smartphones that do not support Qi inductive charging.

³ The WiFi hotspot enables in-vehicle use of the internet with the maximum LTE standard. Use is subject to cost.
⁴ Part of Navigation system Professional.

⁵ Off-board speech recognition, as a functional extension, can be booked in the ConnectedDrive Store.
⁶ Only available in conjunction with ConnectedDrive Services.
⁷ Part of the RTTI equipment.

⁸ Only available in conjunction with interior and exterior mirror package.
⁹ Part of the Parking Assistant Plus package.
¹⁰ Use of Remote 3D View requires Remote Services and Parking Assistant Plus.
 Some ConnectedDrive Services may differ between countries. Please consult your local BMW partner for more information.

EXTERIOR COLOURS.

Discover more with the new BMW catalogue app. Now available for your smartphone and tablet.

■ Standard equipment □ Optional equipment



■ **Non-metallic** 668 Black



□ **Non-metallic** 300 Alpine White¹

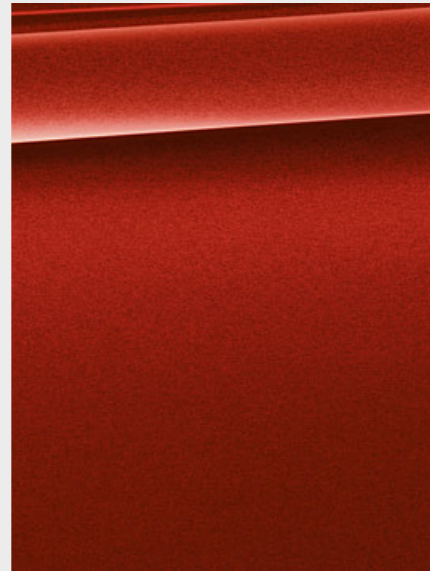

□ **Metallic** C06 Flamenco Red Brilliant Effect²



□ **Metallic** A96 Mineral White

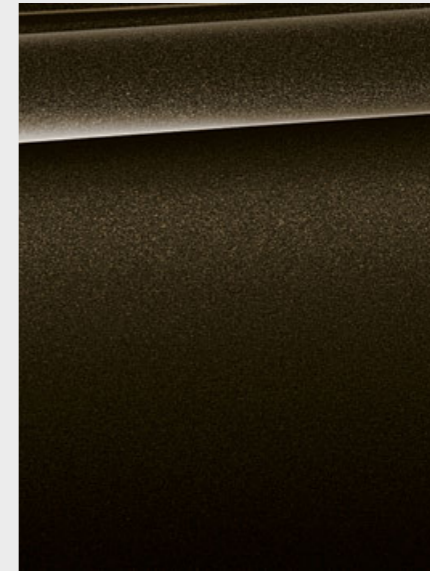

□ **Metallic** C07 Sparkling Storm Brilliant Effect

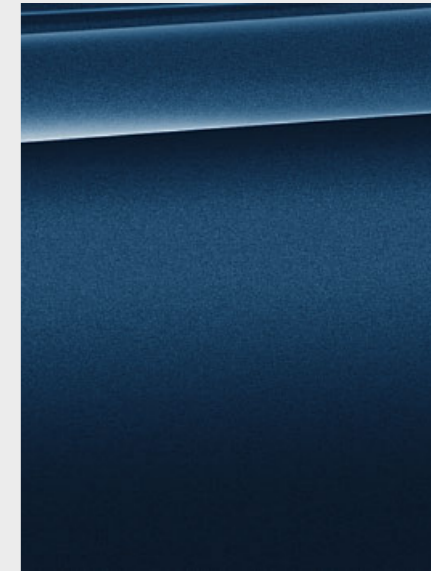

□ **Metallic** C1M Phytonic blue²

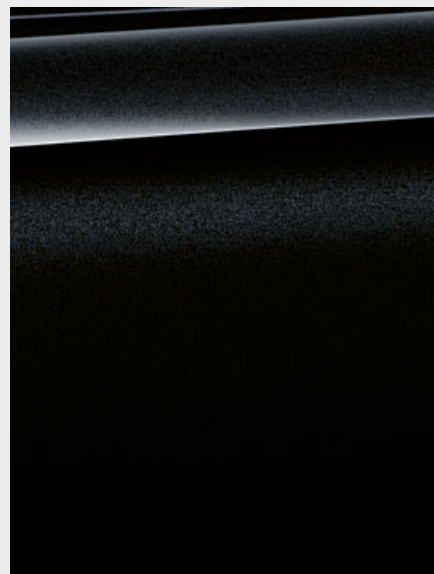

□ **Metallic** 475 Black Sapphire²



□ **Metallic** A83 Glacier Silver²

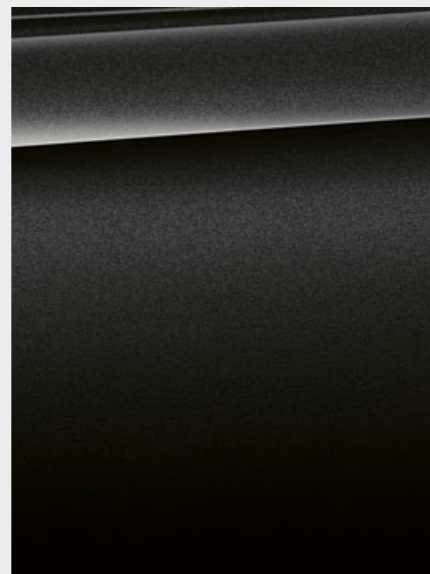

□ **Metallic** A90 Sophisto Grey Brilliant Effect²

M SPORT PACKAGE M SPORT X PACKAGE

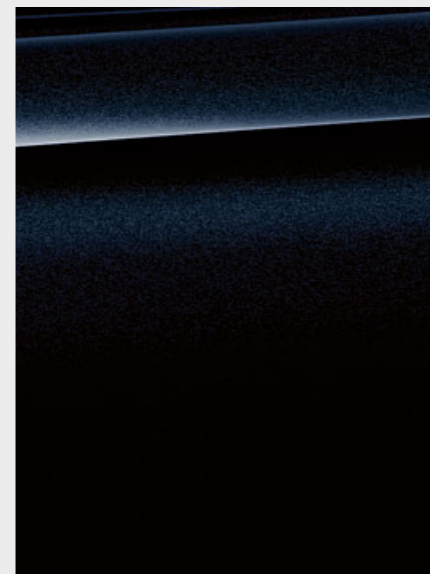

□ **Metallic** 416 Carbon Black³

BMW INDIVIDUAL.

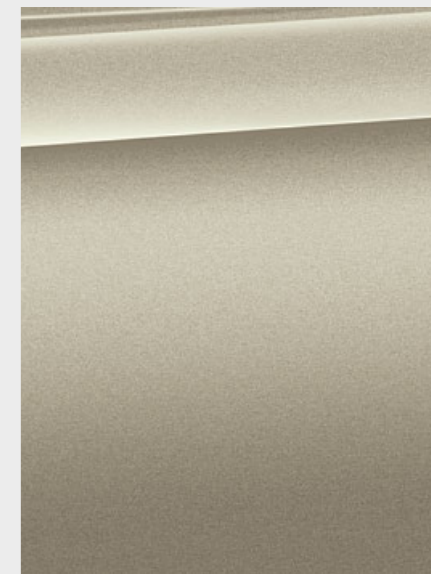

□ **BMW Individual** C1N Sunstone metallic.²

[Colours] The colours printed above are intended to provide you with a first impression of paints and materials available for your BMW. Experience has shown, however, that printed images of paint, upholstery and interior trim colours cannot faithfully reproduce the ac-

tual appearance of the originals. We recommend therefore that you consult your BMW partner who will be able to show you original samples and assist with special requests.

¹ Available as standard for M Sport package and M Sport X package.

² Also optionally available for M Sport package and M Sport X package.

³ Exclusively available in conjunction with M Sport package and M Sport X package.

INTERIOR COLOURS.

Discover more with the new BMW catalogue app. Now available for your smartphone and tablet.

■ Standard equipment □ Optional equipment

CLOTH

Available with

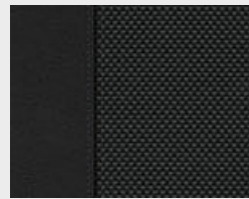

■ Base

Cloth 'Hevelius'
ECHAT Anthracite,
interior colour Black

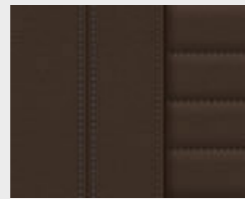

□ Base
□ xLine
□ M Sport package
□ M Sport X package

Leather 'Vernasca' MAMU
Mocha, with
decorative stitching,
interior colour Black¹

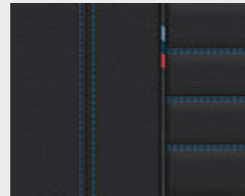

□ M Sport package
□ M Sport X package

Leather 'Vernasca' MANL
Black, contrast
stitching Blue,
interior colour Black³

CLOTH/LEATHER COMBINATION

Available with

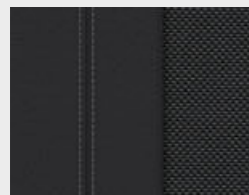

□ Base
■ xLine

Cloth/leather combination 'Vivus' BVAT
Anthracite, interior
colour Black¹



□ xLine
□ M Sport package
□ M Sport X package

Leather 'Vernasca' MAOQ
Oyster with
decorative stitching
and extended
features, interior
colour Black

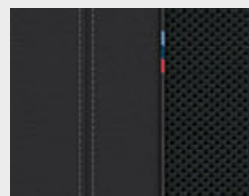

■ M Sport package
■ M Sport X package

Cloth/leather combination 'Vernasca' BWNL
Black, contrast
stitching Blue,
interior colour Black

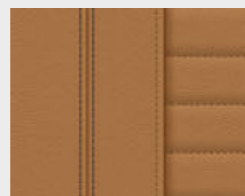

□ xLine
□ M Sport package
□ M Sport X package

Leather 'Vernasca' MAPQ
Cognac with
decorative stitching,
interior colour Black

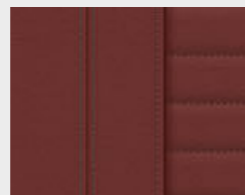

□ xLine
□ M Sport package
□ M Sport X package

Leather 'Vernasca' MAG6
Tacora Red with
decorative stitching,
interior colour Black.

LEATHER

Available with



□ Base
□ xLine
□ M Sport package
□ M Sport X package

Leather 'Vernasca' MAFO
Canberra Beige with
decorative stitching,
interior colour Black²

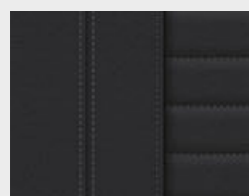

□ Base
□ xLine
□ M Sport package
□ M Sport X package

Leather 'Vernasca' MAH7
Black with
decorative stitching,
interior colour Black²

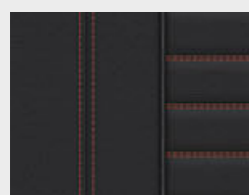

□ M Sport package
□ M Sport X package

Leather 'Vernasca' MAH8
Black, contrast
stitching Red,
interior colour Black³

BMW INDIVIDUAL LEATHER

Available with



□ Base
□ xLine
□ M Sport package
□ M Sport X package

BMW Individual extended fine-grain 'Merino' leather VATQ
Tartufo^{1,4,6}

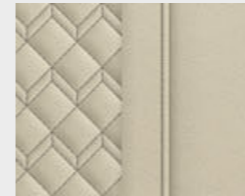

□ Base
□ xLine
□ M Sport package
□ M Sport X package

BMW Individual extended fine-grain 'Merino' leather VAEW Ivory
White^{1,4,6}

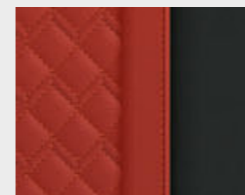

□ Base
□ xLine
□ M Sport package
□ M Sport X package

BMW Individual extended fine-grain 'Merino' leather VAHZ Fiona
Red/Black^{1,4,6}



□ Base
□ xLine
□ M Sport package
□ M Sport X package

4K9 Aluminium fine cutting with highlight trim finisher Pearl Chrome



□ Base
□ xLine
□ M Sport package
□ M Sport X package

4LH Fine-wood trim 'Fineline' Cove with highlight trim finisher Pearl Chrome

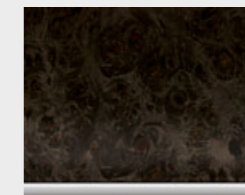

□ Base
□ xLine
□ M Sport package
□ M Sport X package

4LQ Fine-wood trim poplar grain grey with highlight trim finisher Pearl Chrome



■ M Sport X package

4KN Interior trim finishers Aluminium Rhombicle dark with highlight trim finisher Pearl Chrome

INTERIOR TRIMS

Available with

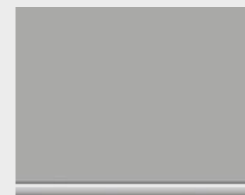

■ Base

4K8 Oxide Silver dark matt with Pearl-Gloss Chrome accent lines

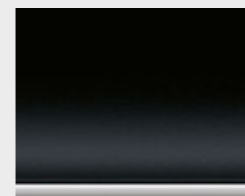

□ Base
■ xLine

4LU Black high-gloss, highlight trim finisher Pearl Chrome

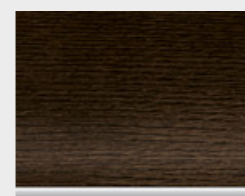

□ Base
□ xLine
□ M Sport package
□ M Sport X package

4K1 Fine-wood trim Oak dark high-gloss with highlight trim finisher Pearl Chrome



■ M Sport package

4K7 Aluminium Rhombicle with highlight trim finisher Pearl Chrome

BMW INDIVIDUAL INTERIOR TRIMS

Available with

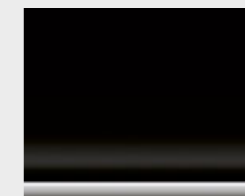

□ Base
□ xLine
□ M Sport package
□ M Sport X package

BMW Individual interior trim 4ML
Piano finish Black⁵

BMW INDIVIDUAL HEADLINER

Available with

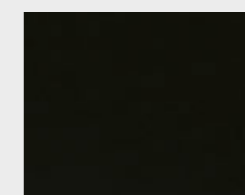

□ Base
□ xLine
□ M Sport package
□ M Sport X package

BMW Individual headliner 775
Anthracite

Please note that even normal long or short-term use can lead to permanent upholstery damage. This can be caused in particular by non-colourfast clothing.

The interior colour is dependent on the chosen upholstery colour.

¹ Only available in conjunction with sports seats.

² For base, only available in conjunction with seats with active seat ventilation.

³ Only available in conjunction with instrument panel Sensatec.

⁴ Only available in conjunction with BMW Individual headliner Anthracite.

⁵ Only available in conjunction with Ambient light.

⁶ For base, only available in conjunction with Door sill finishers with BMW Individual designation.

WHEELS AND TYRES.

Discover more with the new BMW catalogue app. Now available for your smartphone and tablet.



□ 21" M light alloy wheels Double-spoke style 718 M in Bicolor Cerium Grey matt, bright turned, with mixed tyres and run-flat properties, front 8.5J x 21 with 245/40 R21 tyres, rear 9.5J x 21 with 275/35 R21 tyres.¹



□ 21" BMW Individual light alloy wheels V-spoke style 726 I in Bicolor Orbit Grey, bright turned, with mixed tyres and run-flat properties, front 8.5J x 21 with 245/40 R21 tyres, rear 9.5J x 21 with 275/35 R21 tyres.



□ 20" light alloy wheels Y-spoke style 695 Orbit Grey bright turned with mixed tyres, front 8J x 20 with 245/45 R20 tyres, rear 9.5J x 20 with 275/40 R20 tyres.



□ 20" M light alloy wheels Double-spoke style 699 M in Bicolor Orbit Grey, bright turned, with mixed tyres, front 8J x 20 with 245/45 R20 tyres, rear 9.5J x 20 with 275/40 R20 tyres.^{1,2}



□ 20" M light alloy wheels Double-spoke style 787 M in Bicolor Orbit Grey, bright turned, with mixed tyres, front 8J x 20 with 245/45 R20 tyres, rear 9.5J x 20 with 275/40 R20 tyres.³



○ High-quality 20" light alloy wheels V-spoke style 695 in matt Black. TPMS summer complete wheel set with run-flat mixed tyres.



□ 19" light alloy wheels V-spoke style 691 in Reflex Silver, wheel size 7.5J x 19 with 245/50 R19 tyres.



□ 19" light alloy wheels V-spoke style 692 in Bicolor Ferric Grey, bright turned, wheel size 7.5J x 19 with 245/50 R19 tyres.



■ 19" light alloy wheels Y-spoke style 694, Ferric Grey, wheel size 7.5J x 19 with 245/50 R19 tyres.⁴



■ 19" M light alloy wheels Double-spoke style 698 M in Bicolour Ferric Grey, bright turned, wheel size 7.5J x 19 with 245/50 R19 tyres.⁵

¹ Only available in conjunction with M Sport package.
² Runflat tyres standard for M40i and M40d.

³ Only available in conjunction with M Sport X package.

⁴ Only available in conjunction with xLine.

⁵ Only available in conjunction with M Sport package and M Sport X package.

ORIGINAL BMW ACCESSORIES.

Equipment 40 | 41

■ Standard equipment □ Optional equipment ○ Accessories



○ This **contemporary roof box** in Black with titanium silver side trims has a 420-litre capacity and fits all BMW roof rack systems. It can be opened from both sides and features triple central locking on each side which makes it easy to load and provides anti-theft locking.



○ The **BMW Advanced Car Eye 2.0** is a highly sensitive full-HD camera that captures events around the car, even at night. In the event of disturbances and extraordinary movement outside the vehicle, the camera automatically records the situation in order to document possible accidents or (attempted) break-ins.



○ The perfectly fitted, durable **all-weather floor mats** with raised border and elegant design protect the front and rear footwell from moisture and dirt. They are black and feature a black X4 inlay.

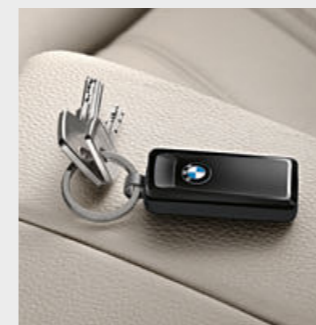

○ For button-free locking/unlocking vehicle and starting the engine. Can be carried using either a clip, keyring or wrist band accessory. **"Sport" version** features the BMW logo.

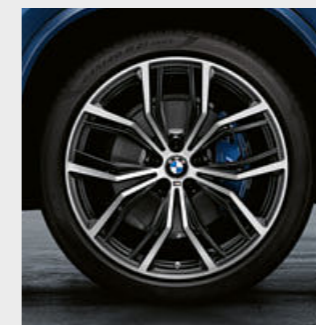

○ 21" **BMW M Performance light alloy wheels** Y-spoke style 701 M, in Bicolor black matt, gloss-lathed. Summer complete wheel set with run-flat mixed tyres.



○ Meticulously hand-made from carbon fibre, the striking **exterior mirror caps** underline the vehicle's high-tech pedigree. Their dynamic design ensures an eye-catching premium look and adds an individual athletic touch.

Discover the wide range of innovative solutions available for the exterior and interior, communication & information, and for transportation & the luggage compartment. Your BMW Partner is on hand to advise you on the whole range of Original BMW Accessories

and can also provide you with a special accessories catalogue. For further information, please visit www.bmw.com/accessories

BMW X4		xDrive20i ⁷	xDrive30i ⁷	M40i ^{*, **, 6, 7}	xDrive20d ⁷	xDrive25d ^{**, 7}	xDrive30d ^{*, 6, 7}	M40d ⁷
Weight								
Unladen EU (xDrive)	kg	1795	1795	1900	1815	1830	-*	1970
Max. permissible (xDrive)	kg	2400	2400	2430	2400	2420	-*	2525
Permitted load (xDrive)	kg	680	680	600	640	640	-*	600
Permitted trailer load, unbraked (xDrive) ²	kg	750	750	750	750	750	-*	750
Permitted trailer load, braked, max. 12% gradient/max. 8% gradient (xDrive) ²	kg	2000/2000	2000/2000	2000/2000	2000/2000	2000/2000	-*	2000/2000
Luggage compartment capacity	l	525-1430	525-1430	525-1430	525-1430	525-1430	-*	525-1430
Engine								
Cylinders/valves		4/4	4/4	6/4	4/4	4/4	-*	6/4
Capacity	cc	1998	1998	2998	1995	1995	-*	2993
Rated output/rated engine speed	kW (hp)/rpm	135 (184)/5000-6500	185 (252)/5200-6500	260 (354)/-*	140 (190)/4000	170 (231)/4400	195 (265)/-*	240 (326)/4400
Max. torque/engine speed	Nm/rpm	290/1350-4250	350/1450-4800	500/-*	400/1750-2500	500/2000	620/-*	680/1750-2250
Power transmission								
Drive configuration		All-wheel	All-wheel	All-wheel	All-wheel	All-wheel	-*	All-wheel
Standard transmission (xDrive)		Steptronic transmission	Steptronic Sport transmission	Steptronic Sport transmission	Steptronic transmission	Steptronic Sport transmission	-*	Steptronic Sport transmission
Performance								
Top speed (xDrive)	km/h	215	240	250 ³	213	230	240	250 ³
Acceleration (xDrive) 0-100 km/h	s	8,3	6,3	4,8	8,0	6,8	5,8	4,9
Consumption - All engines conform to the EU6 standard								
Urban (xDrive)	l/100 km	8,5-8,8	8,4-8,5	-*	5,9-6,3	6,2-6,3	-*	7,2-7,3
Extra-urban (xDrive)	l/100 km	6,3-6,5	6,4-6,7	-*	5,1-5,3	5,1-5,3	-*	5,9-6,3
Combined (xDrive)	l/100 km	7,1-7,3	7,2-7,3	9,0-9,2	5,4-5,6	5,5-5,7	5,9-6,2	6,4-6,6
Exhaust emissions standard (type-certified)		EU6	EU6	EU6	EU6	EU6	EU6	EU6
CO ₂ emissions, combined (xDrive)	g/km	163-168	164-168	209-213	142-149	145-149	156-163	170-173
Tank capacity, approx.	l	65	65	65	60	60	-*	68
Wheels/tyres								
Tyre dimensions		225/60 R18 W	225/60 R18 W	245/45 R20 W/275/40 R20 W	225/60 R18 W	225/60 R18 W	-*	245/45 R20 W/275/40 R20 W
Wheel dimensions		7J x 18	7J x 18	8J x 20/9,5J x 20	7J x 18	7J x 18	-*	8J x 20/9,5J x 20
Material		Light alloy	Light alloy	Light alloy	Light alloy	Light alloy	-*	Light alloy

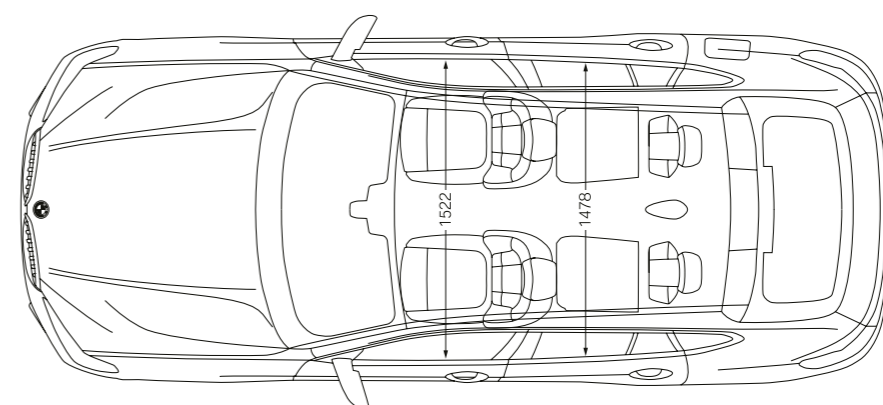
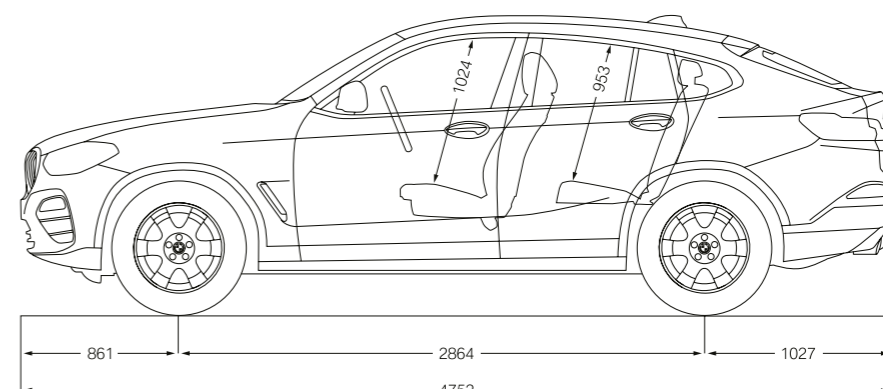
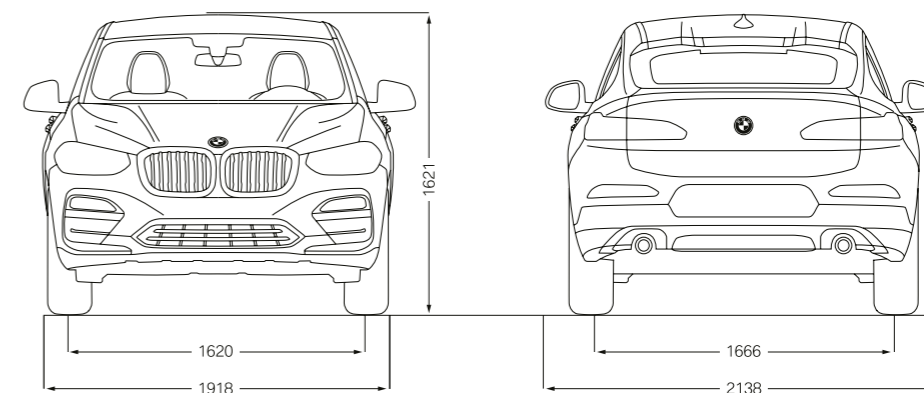

All dimensions in the technical drawings are given in millimetres. Performance, fuel consumption and CO₂ emissions figures refer to vehicles with standard transmission.

* Provisional figures. Any missing figures were unavailable at the time of publication.
** Models/engines for which these values apply can be ordered until 04/15/2018. Please ask your BMW Partner for more detailed information about the availability.

¹ The EC unladen weight refers to a vehicle with standard equipment and does not include any optional extras. The unladen weight includes a 90 % full tank and a driver weight of 75 kg. Optional equipment may affect the weight of the vehicle, the payload and the top speed if the selected equipment has an impact on the vehicle's aerodynamics.

² The actual total weight of the trailer must not exceed the maximum permitted trailer load, taking into account the maximum tow bar download.

³ Electronically limited.

⁴ Performance data of petrol engines apply to vehicles using RON 98 fuel. Fuel consumption data apply to vehicles using reference fuels in accordance with EU Regulation 2007/715. Unleaded RON 91 and higher with a maximum ethanol content of 10% (E10) may also be used. BMW recommends RON 95 super unleaded petrol.

⁵ The data for fuel consumption, CO₂ emissions and energy consumption are determined in accordance with the measurements processes as defined by European Regulation (EU) 2007/715 in the applicable version. Data refer to a vehicle with base-level equipment in Germany, and the ranges account for differences according to the selected wheel and tyre size and the optional equipment and may change during the configuration process. Data for vehicles indicated with (7) have already been determined on the basis of the new WLTP test cycle and adjusted for comparability with NEDC. For these vehicles, values other than those specified here may apply for the assessment of taxes and other vehicle-related charges that are (also) based on CO₂ emissions.

⁶ Available from 08/18.

BMW X4 M40i.

M Performance TwinPower Turbo inline 6-cylinder petrol engine, 260 kW (354 hp), 21" BMW M light alloy wheels Double-spoke style 718 M with mixed tyres, Flamenco Red brilliant effect exterior colour, Sport seats for driver and front passenger in 'Vernasca' Black leather with contrast stitching red, Aluminium Rhombicle interior trim finishers with Pearl Chrome accents, instrument panel in Sensatec black.

The models illustrated in this brochure show the equipment and configuration options (standard and optional) for vehicles produced by BMW AG for the German market. Alterations in standard and optional equipment and the configurations available for the different models, as described in this brochure, may occur after 12/21/2017, the date when this brochure went to press, or according to the specific requirements of other markets. Your local BMW Partner is available to provide further details. Subject to change in design and equipment.

© BMW AG, Munich, Germany. Not to be reproduced wholly or in part without prior written permission of BMW AG, Munich.

411 004 112 20 1 2018 BM. Printed in Germany 2018.

