



Sheer  
Driving Pleasure



# THE FIRST BMW 6 SERIES GRAN TURISMO.

**BMW EFFICIENT DYNAMICS.**  
LESS EMISSIONS. MORE DRIVING PLEASURE.



## THE FIRST BMW 6 SERIES GRAN TURISMO.



## DIGITAL DISCOVERY: THE NEW BMW BROCHURES APP.



More information, more driving pleasure: The new BMW brochures app offers you a brand new digital and interactive BMW experience. Download the BMW brochures app for your smartphone or tablet now and explore new perspectives of your BMW.

## INNOVATION AND TECHNOLOGY.



18 BMW EfficientDynamics



20 BMW Personal CoPilot  
21 BMW ConnectedDrive



22 Suspension and safety

## EQUIPMENT.



24 Models and lines



32 Equipment highlights



36 Exterior colours

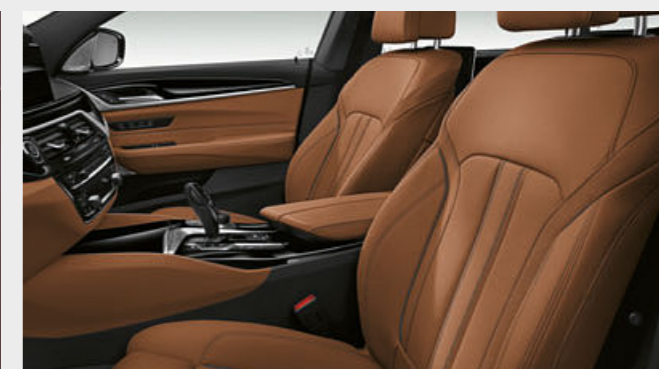

38 Interior colours



40 Wheels and tyres



41 Original BMW Accessories

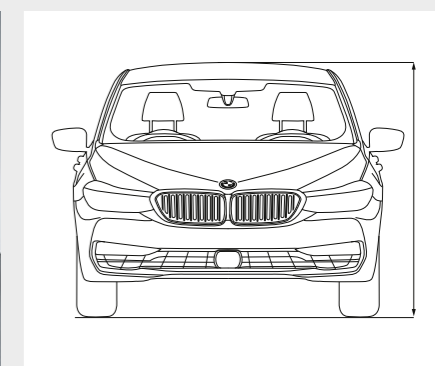

42 Technical data





SENSE AND  
SENSIBILITY HAVE  
NEVER BEEN CLOSER.

---

---





## THE LEADING LOOK.

COUPÉ-STYLE ROOFLINE AND ELEGANT CONTOURS || LONG WHEELBASE  
AND SET BACK GREENHOUSE || FRAMELESS WINDOWS







## WHEN EVEN THE LONGEST JOURNEY FEELS TOO SHORT.

GENEROUS HEAD AND LEGROOM FOR OUTSTANDING COMFORT ON LONG JOURNEYS || EXECUTIVE DRIVE\* || PANORAMA GLASS ROOF\* || AMBIENT LIGHT\* || AMBIENT AIR PACKAGE\* || BOWERS & WILKINS DIAMOND SURROUND SOUND SYSTEM\*

\* Available as optional equipment.





## STAY IN THE KNOW AS YOU GO.

BMW CONNECTED\* || BMW GESTURE CONTROL\* || INTELLIGENT VOICE CONTROL SYSTEM\* || 10.25" TOUCH DISPLAY\* || BMW HEAD-UP DISPLAY\*

\* Available as optional equipment.





# FUNCTIONALITY MEETS DYNAMICS.

ACTIVE REAR SPOILER EXTENDS AUTOMATICALLY AT SPEEDS OF  
110KM/H AND ABOVE || SCULPTED 3-D LED REAR LIGHTS || SPACIOUS  
LUGGAGE COMPARTMENT WITH THROUGH-LOADING SYSTEM







## DYNAMICS ROOTED IN INNOVATION.

ACTIVE AIR STREAM KIDNEY GRILLE WITH WIDE GRILLE FRAME II  
DRIVING ASSISTANT PLUS WITH STEERING AND LANE CONTROL ASSISTANT\* II  
REMOTE CONTROL PARKING\* II ADAPTIVE LED HEADLIGHTS\*

\* Available as optional equipment.





**THE FIRST BMW 6 SERIES GRAN TURISMO HAS EARNED ITS NAME –** IT COMBINES AN EXCEPTIONALLY SPACIOUS INTERIOR WITH MAXIMUM COMFORT, WITHOUT COMPROMISING ANY OF ITS TRADEMARK DRIVING PLEASURE. AND IT PRESENTS A DESIGN THAT PERFECTLY BALANCES OUT DYNAMICS AND AESTHETICS. WITH SO MUCH AUTHORITY AND CONFIDENT ELEGANCE, EVERY KILOMETER IS A SOURCE OF JOY; AND EVERY SENSE REWARDED. **THE LONGEST JOURNEY IS JUST SHORT ENOUGH: IN THE FIRST BMW 6 SERIES GRAN TURISMO.**

**PLENTY OF ROOM  
FOR THE GREATEST  
DEMANDS.**



www.bmw.com/efficientdynamics

**MORE POWER FROM LESS FUEL.**

More power from 3 to 12 cylinders. Consume less, experience more – the **BMW TwinPower Turbo engines** offer the greatest possible dynamic performance with the greatest possible efficiency thanks to the newest injection systems, variable output control and sophisticated turbocharger technology. Whether diesel or petrol, and no matter how many cylinders, the engines from the BMW EfficientDynamics engine family allow markedly more agile power delivery and outstanding responsiveness even at low rpms, while being fuel-efficient and low in emissions.

**MORE DRIVING PLEASURE, LESS EMISSIONS.**

Approximately 33% less CO<sub>2</sub> emissions since 2000: **BMW EfficientDynamics** is a technology package that includes not only the drive, but rather the whole vehicle concept and intelligent energy management. Provided as standard in every BMW, a variety of innovative technologies contribute to continuously improving efficiency. Via engine efficiency measures, electrification, lightweight construction methods and optimised aerodynamics, BMW has managed to reduce the CO<sub>2</sub> emissions of its fleet by 33%.

**MORE SPEED, LESS WEIGHT.**

Lower weight with intelligent lightweight construction. Special consideration for every last detail – intelligent lightweight construction means that the optimal material is found and implemented for each part of the vehicle. With extremely light high-tech materials such as aluminium and carbon fibre, **BMW EfficientLightweight** is pursuing the goal of minimising vehicle weight. That leads to even more dynamic performance, increased stability and heightened vehicle safety and comfort.



**INTELLIGENT START STOP FUNCTION**

The Intelligent Start/Stop function<sup>1</sup> enhances driving comfort with the help of the interaction of the navigation, camera and radar data. It switches the engine off only when an extended standing time is expected and the energy required to start the engine is likely to be lower than that saved when it is shut down.

**AERODYNAMICS**

With targeted measures focusing on Aerodynamics, BMW has optimised drag coefficient and efficiency as well as interior acoustics. Fuel consumption has also been reduced. The Active air stream kidney grille, the Air Breather, the Air curtain on the front wheels and the Aero wheels are all targeted and detailed measures to further reduce air resistance.

**DRIVING EXPERIENCE CONTROL INCL. ADAPTIVE MODE**

The Driving Experience Control offers the driver the choice between the standard COMFORT mode, ECO PRO Mode, geared towards efficiency, and SPORT mode, which enables even more dynamic driving. The new interactive function ADAPTIVE Mode continuously adjusts the Dynamic Damper Control, the steering and the Steptronic transmission to suit the current driving situation.

**IN THE FIRST BMW 6 SERIES GRAN TURISMO.**

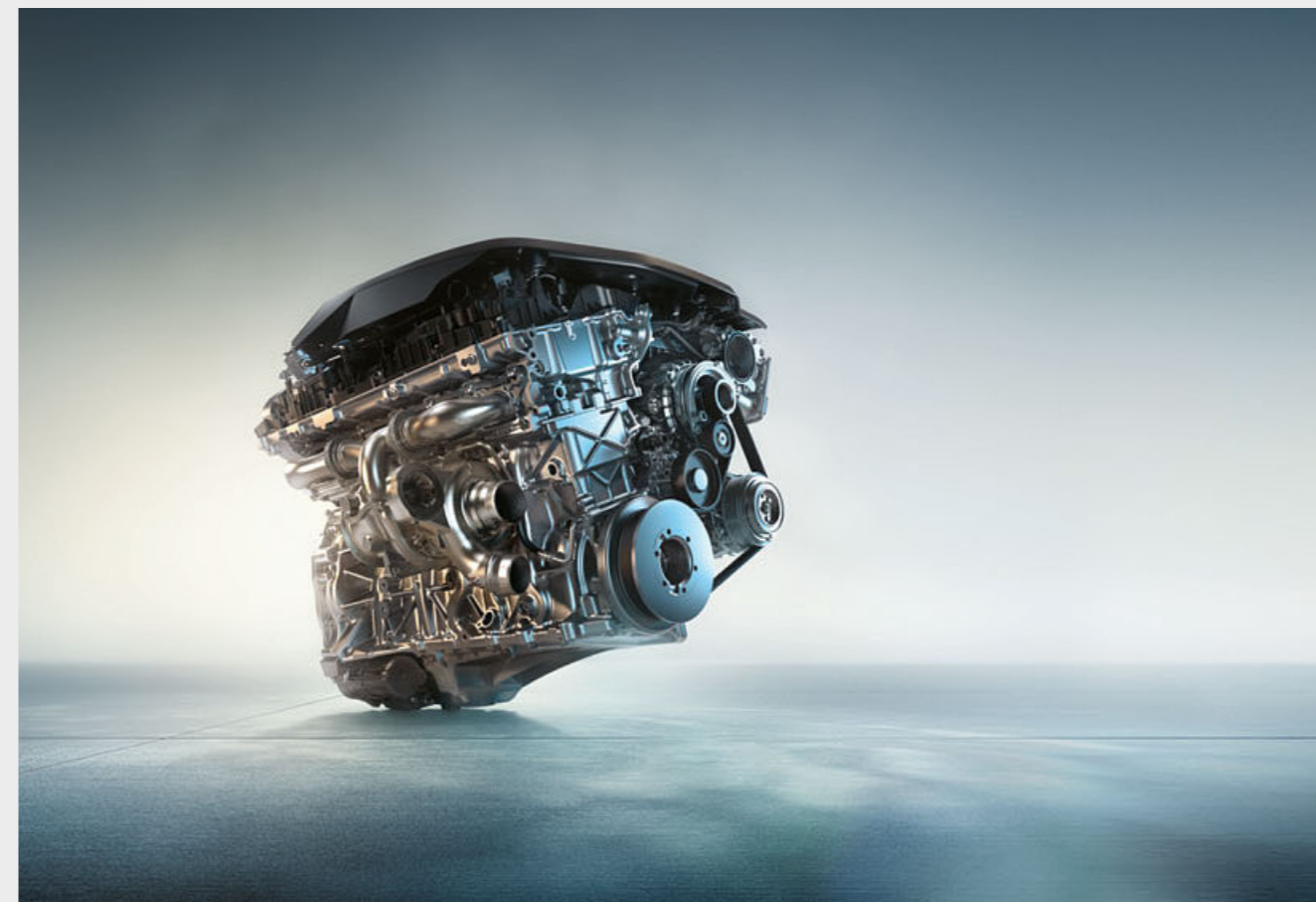

**BMW 630i<sup>3</sup>**

- BMW TwinPower Turbo 4-cylinder petrol engine with 190 kW (258 hp) and 400 Nm torque
- Acceleration 0–100 km/h: 6.3 s
- Top speed: 250 km/h<sup>2</sup>
- Combined fuel consumption: 6.2–6.6 l/100 km
- CO<sub>2</sub> emissions combined: 142–152 g/km

**BMW 640i<sup>3</sup> / 640i xDrive<sup>3</sup>**

- BMW TwinPower Turbo 6-cylinder petrol engine with 250 kW (340 hp) and 450 Nm torque
- Acceleration 0–100 km/h: 5.4 s (xDrive: 5.3 s)
- Top speed: 250 km/h<sup>2</sup>
- Combined fuel consumption: 7.0–7.4 l/100 km (xDrive: 7.7–8.2 l/100 km)
- CO<sub>2</sub> emissions combined: 159–169 g/km (xDrive: 177–187 g/km)

**BMW 630d\* / 630d xDrive\***

- BMW TwinPower Turbo 6-cylinder diesel engine with 195 kW (265 hp) and 620 Nm torque
- Acceleration 0–100 km/h: 6.1 s (xDrive: 6.0 s)
- Top speed: 250 km/h<sup>2</sup>
- Combined fuel consumption: 5.5–5.8 l/100 km (xDrive: 5.7–5.9 l/100 km)
- Combined CO<sub>2</sub> emissions: 146–152 g/km (xDrive: 151–156 g/km)

**BMW 640d xDrive\***

- BMW TwinPower Turbo 6-cylinder diesel engine with 235 kW (320 hp) and 680 Nm torque
- Acceleration 0–100 km/h: 5.3 s
- Top speed: 250 km/h<sup>2</sup>
- Combined fuel consumption: 5.9–6.1 l/100 km
- Combined CO<sub>2</sub> emissions: 155–161 g/km

<sup>\*</sup>The data for fuel consumption, CO<sub>2</sub> emissions and energy consumption are determined in accordance with the measurement processes as defined by European Regulation (EC) 715/2007 in the applicable version. Data refer to a vehicle with base-level equipment in Germany, and the ranges account for differences according to the selected wheel and tyre size and the optional equipment and may change during the configuration process. Data for vehicles indicated with \* have already been determined on the basis of the new WLTP test cycle and adjusted for comparability with NEDC.

<sup>3</sup> Models/engines for which these values apply can be ordered until 04/15/18. Please ask your BMW Partner for more detailed information about the availability.

The figures for output, fuel consumption and CO<sub>2</sub> emissions refer to vehicles with a standard transmission. For further information on fuel consumption and CO<sub>2</sub> emissions, please see pages 42 | 43 or consult your BMW partner.

<sup>1</sup> Only available in conjunction with additional equipment.  
<sup>2</sup> Electronically regulated.



## BMW Personal CoPilot

By your side, when you decide.

### THE INNOVATIVE BMW ASSISTANCE SYSTEMS.

Enjoy the ultimate in comfort and safety with the BMW Personal CoPilot. Whether it's for driving or parking, you can rely on BMW Personal CoPilot driver assistance systems in every situation. The most cutting-edge systems, such as radar, ultrasound and cameras, dependably register the vehicle's surroundings, forming the basis for intelligent driver assistance systems. Either activated when desired, or as emergency assistance in the background – BMW Personal CoPilot assistance systems make every journey in your BMW even safer and more enjoyable.

### CLOSER TO AUTONOMOUS DRIVING THAN EVER BEFORE.

Autonomous driving is not a utopia, it is the future: All over the world, BMW Personal CoPilot test vehicles are already driving completely independently without the driver's intervention and not only show impressively how mobility will change in the near future – they also offer an outlook on the next level of driving pleasure. Even today, BMW Personal CoPilot already offers a large number of intelligent semi-automated assistants that actively support and relieve the driver in almost every driving situation.

### SIMPLY PARK IT.

Intelligent parking assistance systems from BMW Personal CoPilot are available so that you don't just look forward to every ride in your BMW, but also to parking. For example, the Parking assistant already displays suitable parking spaces as you drive past and, depending on the BMW model, runs the parking process either partially or completely independently. But here too, automation will continue to advance, so that in the future it will be possible for vehicles without drivers to search for a parking space and execute the parking process autonomously.

### REMOTE CONTROL PARKING.

The Remote Control Parking function<sup>1,2,3</sup> allows the driver to conveniently get out of the vehicle before parking it via remote control by moving it forward into, or reversing out of, a tight parking space or garage. The Remote Control Parking function is activated by the driver once outside the car, with the BMW display key.

### DRIVING ASSISTANT PLUS.

Driving Assistant Plus<sup>1,2</sup> offers greater comfort and security during monotonous or complex driving situations. These can include traffic jams, stop-and-go traffic or long journeys through the city, on country roads or motorways, along with navigating junctions and lane changes.

### ACTIVE CRUISE CONTROL WITH STOP&GO FUNCTION

Active cruise control with Stop&Go function<sup>1</sup>, Speed Limit Info including No-overtaking indicator<sup>3</sup> and Approach control warning with braking function reacts to stationary vehicles, independently maintains a preselected distance from the vehicle ahead and controls speed down to standstill, automatically accelerating again as soon as traffic flow allows it.

**IN THE BMW 6 SERIES GRAN TURISMO.**

## BMW ConnectedDrive

Connected to be free.

Innovation and Technology 20 | 21

### CONNECTED FOR OVER 40 YEARS.

Focused on the future – from the very beginning. By the 1970s, BMW had already made headway in connected mobility. Another milestone of the digital future was surpassed in 1999: vehicles with built-in SIM cards. Then came the first online functionality, Google Services and innovative display systems such as the BMW Head-Up Display. Throughout this process, the desires of the customer have always taken centre stage. In a first for a premium automobile manufacturer, BMW makes it possible to book and pay for services flexibly via the BMW ConnectedDrive Store, in the vehicle or on a computer at home. And with the introduction of BMW Connected and the Open Mobility Cloud, BMW is taking the next steps into the future of mobility.

### MORE THAN 20 SERVICES IN THE BMW CONNECTED DRIVE STORE.

The ConnectedDrive Services equipment forms the basis for intelligent BMW ConnectedDrive functions. This equipment also provides access to the BMW ConnectedDrive Store, in which services can be ordered and extended easily, any time and anywhere to suit the user's individual requirements – for example with the Concierge Service or Online Entertainment, which turn every drive into a convenient and entertaining experience.

### IN TOUCH 24/7 WITH BMW CONNECTED.

What would it be like if you were never late again? What if your BMW already knew your preferred destinations? How would you like reliable navigation, whether you're sitting in your vehicle or not? BMW Connected provides you with the information you want, when and where you want it. BMW Connected is a personal mobility assistant which facilitates your everyday mobility and aids you in reaching your destinations relaxed and on time. With the BMW Connected app, mobility-relevant information such as recommendations for optimal departure times are available at any time via smartphone or smartwatch and can be seamlessly transmitted to the car.

### ON-STREET PARKING INFORMATION.

On-Street Parking Information<sup>1,2,4</sup> simplifies the search for a parking space by searching for a free parking space in selected big cities. The streets on the navigation map are colour-coded to reflect the probability of a free space. Dark blue indicates a high probability and light blue a medium probability of finding a free parking space on the street.

### REMOTE 3D VIEW.

With Remote 3D View<sup>1,5</sup>, the user can see the parked vehicle's surroundings from a distance on a smartphone. The function can be activated via the BMW Connected App (for iOS). It also allows the user to observe the area around the vehicle from a distance as a 3D image.

### REMOTE SERVICES.

With the Remote Services<sup>2</sup> of the BMW Connected App, various functions of the vehicle, such as locking and unlocking the car or displaying the car location, can be operated remotely. The vehicle's air conditioning can also be started immediately, or programmed to turn on at a later time.<sup>5</sup>

**IN THE BMW 6 SERIES GRAN TURISMO.**

<sup>1</sup> Available as optional equipment.

<sup>2</sup> Only available in conjunction with additional equipment.

<sup>3</sup> Only available in conjunction with a navigation system.

<sup>4</sup> On-Street Parking Information available only for selected models and markets. This feature is only available in conjunction with ConnectedDrive Services and a navigation system. Only available in conjunction with Real Time Traffic Information.

<sup>5</sup> Remote Services and Parking Assistant Plus are required for the use of Remote 3D View.

<sup>6</sup> Requires BMW ConnectedDrive Services.

Some ConnectedDrive Services may differ between countries. Please consult your local BMW partner for more information.



■ Standard equipment □ Optional equipment



The intelligent **BMW xDrive all-wheel drive system** smoothly and variably distributes drive power to the front and rear wheels for maximum traction, driving dynamics and safety in every driving situation. For even better agility, the electronically controlled power distribution for instance counterbalances oversteer or understeer on bends.

**Integral Active Steering**<sup>1</sup> combines support that varies based on the steering angle on the front axle, and rear wheels that also contribute to steering. At lower speeds, it offers greater manoeuvrability and agility by turning the rear wheels opposite the front wheels. Beginning around 60 km/h, the rear wheels turn parallel to the front wheels, to increase stability and comfort.

The **Adaptive 2-axle air suspension**<sup>1</sup> ensures extremely comfortable driving with great driving dynamics. Unlike steel suspension, air suspension consists of air-filled rubber pads that keep the vehicle evenly elevated – regardless of the driving mode and even when carrying a heavy load – as the air pressure inside the pads is constantly adjusted.

The **Executive Drive suspension control system**<sup>1,2,3</sup> ensures exceptional driving comfort and outstanding driving dynamics at the same time. The system is based on active stabilisers that electro-mechanically regulate the suspension continually during the journey, thereby minimising the movement of the car body.

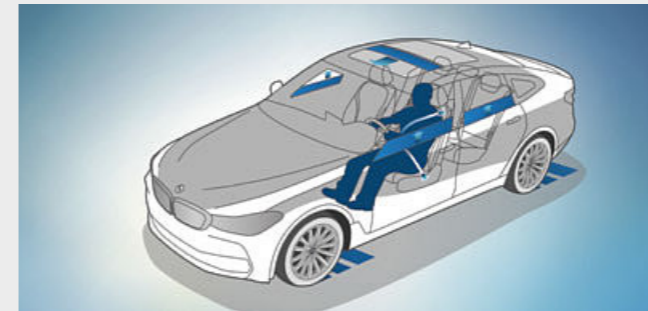

□ **Active Protection** is the BMW ConnectedDrive preventive passenger protection system. Active Protection warns the driver if it detects signs of tiredness, safety belts are pretensioned in critical situations, electric seats are returned to upright positions and the windows and sliding roof are closed. After an accident occurs, the brakes are automatically applied until the car reaches a standstill.

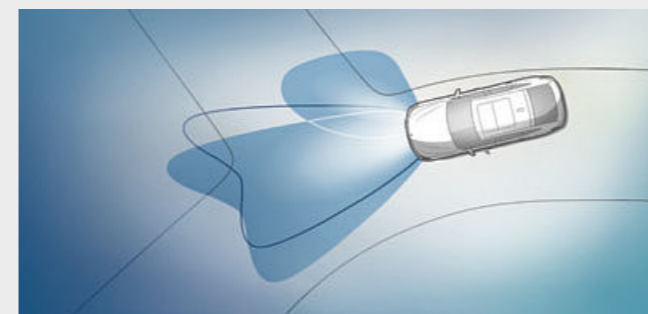

□ The Adaptive headlights, variable city and motorway light distribution and BMW Selective Beam provide optimum illumination of the road when driving in the dark. Even at a standstill, the integrated cornering lights are automatically activated by signalling or turning the steering wheel and are active at speeds of up to 35 km/h.

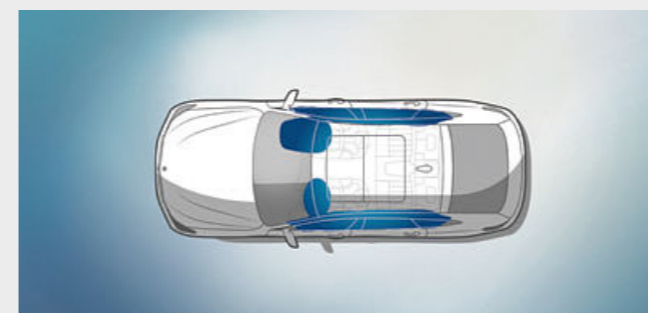

■ **Airbags for driver and front passenger** are part of the optimally coordinated safety components in a BMW. Overall, six airbags provide targeted protection: the driver and front passenger airbags, the head airbags for the entire window surface on the side, and the side airbags integrated into the front seat backrests.

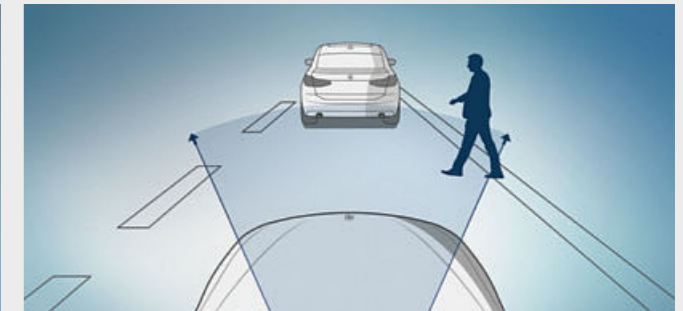

□ The **safety package Driving Assistant** includes the camera-based systems Approach control warning and Person warning with light city braking function<sup>4</sup>, Speed Limit Info including No-overtaking<sup>5</sup> indicator and Lane Departure Warning, as well as the radar-based equipment Crossing traffic warning rear, Lane Change Warning and Rear collision prevention.

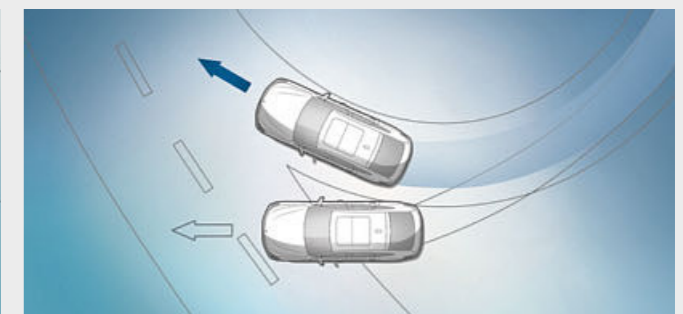

■ **Dynamic Stability Control (DSC)** permanently assesses the vehicle's movements and stabilises it using engine and braking regulation when unstable driving conditions are detected. Additional features of DSC are, for example, brake drying, braking readiness or the Hill-Start assistant, which holds the vehicle briefly in place when starting on inclines to prevent it from rolling backwards.

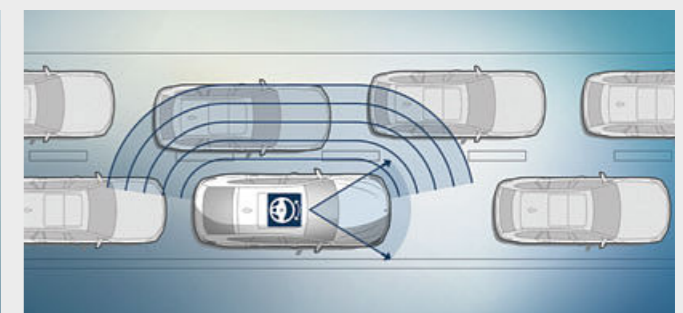

□ **Lane Keeping assistant with active side collision protection**<sup>6</sup>: assists the driver at speeds between 70 km/h to 210 km/h with convenient corrective steering interventions, helping to stay in the lane and actively avoid potential side impacts.

<sup>1</sup> Available as optional equipment.  
<sup>2</sup> Not available with 630i.

<sup>3</sup> Only available in conjunction with Integral Active Steering.  
<sup>4</sup> This function can be limited by darkness and fog.

<sup>5</sup> Only available in conjunction with navigation system.  
<sup>6</sup> Part of the Driving Assistant Plus package.



Discover more with the new BMW catalogue app. Now available for your smartphone and tablet.

■ Standard equipment □ Optional equipment



■ The Sport leather steering wheel with three spokes lends the cockpit a premium yet sporty look. It features decorative airbag trim in leather with ornamental seams. Its thinner rim and contoured thumb rests are perfectly shaped with an exceptionally pleasant feel.



■ The front seats and rear row of seats offer comfortable seating for up to five people. All the seats are fitted with headrests and three-point retractable seat belts. The rear row of seats can safely accommodate three child seats, and passengers in the rear enjoy a generous amount of leg and foot room.

**Selected base model interior equipment features:**

- Sport leather steering wheel
- Leather 'Dakota' standard seats
- Semi-electric Seat adjustment for driver and front passenger
- Interior trim finisher in Oxide Silver dark matt with highlight trim finishers Pearl Chrome
- Radio BMW Professional with six speakers
- Automatic air conditioning with 2-zone control (includes extended features for 640i and 640i xDrive models)
- Hands-free facility with USB interface
- Cruise control with braking function
- 8-speed Steptronic transmission
- Through-loading system with a rear backrest that can be folded down in a 40:20:40 split

**Selected base model exterior equipment features:**

- LED headlights
- Rear lights with LED technology
- 17" light alloy wheels V-spoke style 618
- Active rear spoiler
- Automatic tailgate operation
- Park Distance Control (PDC), front and rear



■ 17" light alloy wheels V-spoke style 618, 7.5J x 17 with 225/60 R17 tyres.



□ 20" light alloy wheels V-spoke style 628 Bicolour with mixed tyres and run-flat properties, front 8.5J x 20 with 245/40 R20 tyres, rear 10J x 20 with 275/35 R20 tyres.



Discover more with the new BMW catalogue app. Now available for your smartphone and tablet.

■ Standard equipment □ Optional equipment



■ Open-pored fine-wood trim "Fineline" Cove with highlight trim finisher Pearl Chrome add to the sophisticated character of the cockpit design.



□ The comfort seats in the Exclusive leather 'Nappa' Ivory White with contrasting piping emphasise the elegant flowing lines of the interior and provide optimal ergonomic adjustment.

#### Luxury Line interior equipment:

- Door sill finishers in aluminium, illuminated with "Luxury Line" designation
- Seats in Leather 'Dakota' with line-specific stitching and leather piping; other upholstery available
- Sport leather steering wheel in Black, alternatively in Dark Coffee
- Car key with buttons and Chrome detailing in high-gloss
- Instrument panel in Sensatec Black or Dark Coffee
- Interior trim finishers in fine-wood trim 'Fineline' Ridge with highlight trim finisher in Pearl Chrome; other trims available
- Variable ambient light in six colours including the welcome light carpet feature
- Electrical backrest adjustment in the second row of seats, including comfort-oriented seat upholstery

#### Luxury Line exterior equipment:

- BMW kidney grille with exclusively designed vertical slats and grille frame in Chrome high-gloss
- Front bumper with specific design elements in Chrome high-gloss
- LED fog lights
- 19" light alloy wheels Multi-spoke style 644 Ferric Grey bright turned, alternatively
- 20" light alloy wheels W-spoke style 646, forged and high-gloss polished; other wheels available
- Side window surrounds in Chrome high-gloss, window recess finisher, B-pillar, mirror base and mirror foot in Black high-gloss
- Rear bumper with specific horizontal design elements on the rear diffuser in Chrome high-gloss
- Tailpipe trim strip in Chrome high-gloss, on both sides or with free-form



■ Door sill finishers in Aluminium, illuminated with "Luxury Line" designation.



■ 19" light alloy wheels Multi-spoke style 644 Ferric Grey gloss-lathed, 8.5J x 19 with 245/45 R19 tyres.



□ 20" light alloy wheels W-spoke style 646, front wheel size 8.5J x 20 with 245/40 R20 tyres, back wheel size 10J x 20 with 275/35 R20 tyres.



Discover more with the new BMW catalogue app. Now available for your smartphone and tablet.

■ Standard equipment □ Optional equipment



□ The Fine Brushed Aluminium interior trim with Pearl Chrome accent line adds sporty highlights to the interior.



■ The sport seats in leather „Dakota“ Black with exclusive stitching mirror the dynamic character of the exterior design.

### Sport Line interior equipment:

- Door sill finishers in aluminium, illuminated with “Sport Line” lettering
- Sport seats for driver and front passenger
- Seats in Leather „Dakota“ with line-specific stitching and leather piping, alternatively
- Seats in Leather „Nappa“; other upholsteries available
- Car key with buttons and Chrome detailing in high-gloss
- Interior trim finishers in Black high-gloss with accent in Pearl Chrome; other trims available
- Instrument panel in Black, alternatively
- Instrument panel in Sensatec Black<sup>1</sup> or Dark Coffee<sup>1</sup>

### Sport Line exterior equipment:

- BMW kidney grille with vertical slats in Black high-gloss and grille frame in Chrome high-gloss
- Front bumper with specific design elements in Black high-gloss
- LED fog lights
- 19" light alloy wheels V-spoke style 685 Orbit Grey bright turned, alternatively
- 20" light alloy wheels V-spoke style 686 Jet Black, bright turned; other wheels available
- Side window surrounds, window recess finisher, B-pillar, mirror base and mirror foot in Black high-gloss
- Rear bumper with specific horizontal design elements on the rear diffuser in Black high-gloss
- Tailpipe trim in Black Chrome, circular on both sides or with free-form



■ 19" light alloy wheels V-spoke style 685 Orbit Grey gloss-lathed, 8.5J x 19 with 245/45 R19 tyres.



□ 20" light alloy wheels V-spoke style 686 Jet Black non-metallic, gloss-lathed, with mixed tyres and run-flat properties, front 8.5J x 20 with 245/40 R20 tyres, rear 10J x 20 with 275/35 R20 tyres.

<sup>1</sup> Colour depends on the selected upholstery colour.



# M SPORT PACKAGE.

Discover more with the new BMW catalogue app. Now available for your smartphone and tablet.

powered by 

■ Standard equipment □ Optional equipment



□ The M leather steering wheel enables precise control, while the BMW Individual interior trim finishers in piano finish Black with highlight trim finishers Pearl Chrome underscore the car's athletic design.



■ The sport seats in Cognac Dakota leather with exclusive stitching create a powerful look, while tall side bolsters and electric seat adjustment ensure comfortable support.

## M Sport package interior equipment:

- M door sill finishers, illuminated
- Sport seats for driver and front passenger in Leather „Dakota“ Black with exclusive M look with blue contrast stitching; other upholsteries available
- M leather steering wheel with multifunction buttons
- BMW Individual headliner Anthracite
- Instrument cluster with M specific design in SPORT mode
- Interior trim finishers in Aluminium Rhombicle with highlight trim finishers in Pearl Chrome, other trims available
- M driver's footrest with M specific pedal covers
- Car key with exclusive M designation
- Instrument panel in Sensatec Black or Dark Coffee

## Sport package exterior equipment:

- Aerodynamics package with front apron, side skirts and rear apron with diffuser insert in Dark Shadow metallic
- BMW kidney grille with vertical slats in Black high-gloss and grille frame in Chrome high-gloss
- 19" M light alloy wheels Double-spoke style 647 M with mixed tyres; other wheels available
- M Sport brake with brake callipers in Dark Blue metallic and M logo
- BMW Individual high-gloss Shadow Line
- M logo on the front side panels
- Exterior mirror caps in body colour
- Tailpipe trim strip in Chrome high-gloss, on both sides
- Exclusive paintwork in Carbon Black; other paintworks available



■ 19" M light alloy wheels Double-spoke style 647 M Bicolour with mixed tyres and run-flat properties, front 8.5J x 19 with 245/45 R19 tyres, rear 9.5J x 19 with 275/40 R19 tyres.



□ 20" M light alloy wheels Double-spoke style 648 M Bicolour with mixed tyres and run-flat properties, front 8.5J x 20 with 245/40 R20 tyres, rear 10J x 20 with 275/35 R20 tyres.

■ The high-performance M Sport brake is distinguished by exclusive dark blue brake callipers with M lettering and outstanding braking performance.



# EQUIPMENT HIGHLIGHTS.

Discover more with the new BMW catalogue app. Now available for your smartphone and tablet.

■ Standard equipment □ Optional equipment



■ To improve stability, the Active rear spoiler automatically extends at a speed of over 110 km/h and retracts once the speed returns to 70 km/h.



□ When open, the Panorama glass roof provides a great deal of fresh air. Closed, it creates a bright, light-flooded atmosphere in the interior. It opens and closes completely automatically at the push of a button, or remotely, and is equipped with slide and lift functions, roller sunblind and wind deflector.



□ The Adaptive LED headlights include BMW Selective Beam, cornering lights and adaptive headlights. The light colour is similar to daylight and provides an ideal, even illumination of the road to improve visibility and make driving in the dark less tiring. The iconic light design with four light elements makes the vehicle recognisable as a BMW even at night.

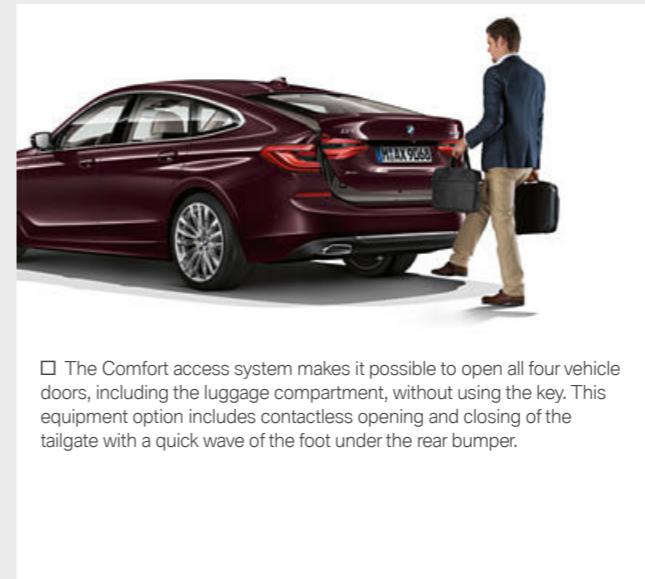

□ The Comfort access system makes it possible to open all four vehicle doors, including the luggage compartment, without using the key. This equipment option includes contactless opening and closing of the tailgate with a quick wave of the foot under the rear bumper.

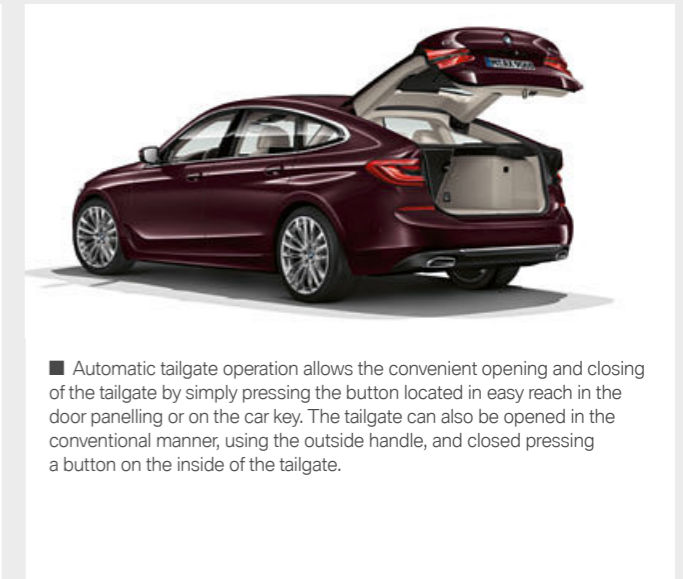

■ Automatic tailgate operation allows the convenient opening and closing of the tailgate by simply pressing the button located in easy reach in the door panelling or on the car key. The tailgate can also be opened in the conventional manner, using the outside handle, and closed pressing a button on the inside of the tailgate.



□ LED fog lights increase short-range visibility in fog or precipitation, improving safety. The colour of the light they emit is remarkably similar to daylight. They also consume little energy and have a very long lifespan. The fog lights give the front of the car a high-tech, modern appearance.



■ The rear lights with lighting elements in LED technology consist of individual high-performance LED lighting elements and have the characteristic, striking BMW L-shape, meaning that the vehicle is clearly recognisable as a BMW even in the dark.



□ The Remote Control Parking<sup>1</sup> function allows the driver to conveniently get out of the vehicle before parking it via remote control by moving it forward into, or reversing out of, a tight parking space or garage. The Remote Control Parking function is activated by the driver once outside the car, with the BMW display key.



□ The high-performance M Sport brake is distinguished by exclusive dark blue brake callipers with M lettering and outstanding braking performance.



# EQUIPMENT HIGHLIGHTS.

Discover more with the new BMW catalogue app. Now available for your smartphone and tablet.

■ Standard equipment □ Optional equipment



□ The Bowers & Wilkins Diamond surround sound system<sup>1-4</sup> with 1,400W amplifier and two diamond tweeters features outstanding studio-quality sound for every seat in the car. 16 carefully positioned speakers ensure a mesmerising sound experience. The speakers are illuminated, visually emphasizing the system's outstanding sound quality.



□ Ambient light creates a relaxed, cosy lighting atmosphere in the interior. The Welcome Light Carpet illuminates the area in front of the car doors when entering and exiting. Six dimmable light designs in White, Blue, Orange, Bronze, Lilac and Green are available.



□ Rear-seat entertainment Professional<sup>1,6</sup> includes two separate 10.2" colour screens that can be tilted and a Blu-ray drive. This makes it possible to use the navigation system or the Internet while on the road (with an existing mobile phone contract). Features remote control, USB port and ports for MP3 players, games consoles and headphones (including wireless headphones).



■ The Through-loading system consists of rear seat backrests that are divided in a 40:20:40 ratio, guaranteeing more flexibility when transporting people and objects. For example, two passengers can be seated comfortably in the rear, while long objects such as ski and snowboard bags can be transported at the same time.



□ The Instrument panel in Sensatec lends the interior of the vehicle a highly exclusive atmosphere. The artificial leather is applied directly to a semi-rigid foam, and features an impressively soft surface. The wear-resistant material is finished with attractive double lap seams.



□ The Automatic air conditioning with 4-zone control comes with the equipment included in Automatic air conditioning with 2-zone control with extended contents, along with two air vents in the B columns. Additionally, the rear passengers can individually adjust their own climate via a separate control element with display and the glove compartment can be cooled.



□ The BMW display key shows various information about the vehicle's status and allows selected functions to be controlled with an integrated touch display.



□ The M seat<sup>5</sup> belts with belt tensioner and belt force limiter boast an exquisite woven highlight in the classic M colours.



□ The Rear view camera enables improved orientation when reversing at speeds below 15 km/h, for example when parking. It shows the area behind the car on the Control Display. Interactive track lines for measuring distance and turning circles assist the driver when manoeuvring, obstacles are marked in colour.

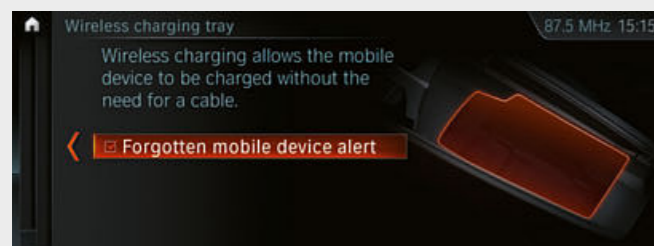

□ Telephony with wireless charging<sup>2</sup> includes a wireless charging dock and additional USB ports. A roof aerial connection improves mobile reception. Two mobile telephones and an audio player can be connected simultaneously via Bluetooth. Also included are: Bluetooth Office and the technical capacity for a WiFi hotspot.<sup>3</sup>

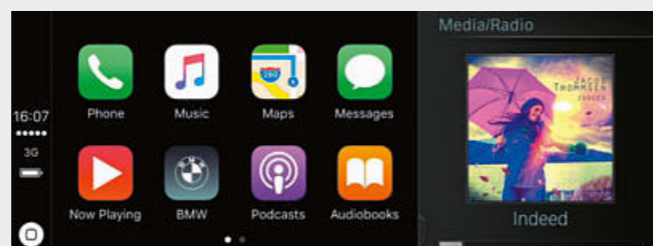

□ Preparation for Apple CarPlay<sup>®1,4</sup> supports the convenient and wireless use of selected iPhone<sup>®</sup> functions in the vehicle. This allows smartphone content and functions such as music, iMessages/text messages, telephony, Siri, navigation and selected third-party apps to be displayed and operated via the vehicle's user interface and via Voice control.



□ The Surround View system<sup>5</sup> makes parking easier by making the area around the car visible with Top View, a Panorama View with automatic activation as well as a 3D View.

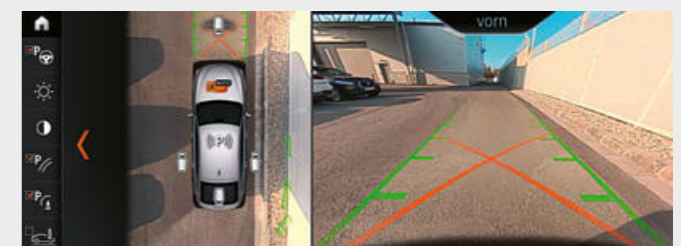

□ The equipment package Parking Assistant Plus<sup>6</sup> makes parking and manoeuvring the vehicle easier. It features Surround View including Top View, Remote 3D View, PDC as well as a lateral parking aid, the Active PDC emergency braking function and the Parking Assistant with linear guidance that provides fully automatic parking both parallel and perpendicular to the road.

<sup>1</sup> Only available in conjunction with the Navigation system Professional.  
<sup>2</sup> Supports inductive charging for Qi-compatible mobile phones. Special charging cases are available from Original BMW Accessories for selected smartphones that do not support the Qi standard for inductive charging. The WiFi hotspot fulfils all in-vehicle requirements for use of the internet with the maximum LTE standard. Usage is subject to cost.

<sup>3</sup> Supports inductive charging for Qi-compatible mobile phones. Special charging cases are available from Original BMW Accessories for selected smartphones that do not support the Qi standard for inductive charging. The WiFi hotspot fulfils all in-vehicle requirements for use of the internet with the maximum LTE standard. Usage is subject to cost.

<sup>4</sup> The compatibility and range of functions from Apple CarPlay<sup>®</sup> depend on the model year and the software installed on the iPhone<sup>®</sup>. When the Apple CarPlay<sup>®</sup> preparation is used, selected vehicle data is transferred to the phone. The mobile phone manufacturer is responsible for further data processing.  
<sup>5</sup> Only available in conjunction with additional equipment.

<sup>6</sup> Part of the Parking Assistant Plus.  
 Optional and standard equipment vary according to country. Some ConnectedDrive Services may differ between countries. Please consult your local BMW partner for more information.



# EXTERIOR COLOURS.

Discover more with the new BMW catalogue app. Now available for your smartphone and tablet.

■ Standard equipment □ Optional equipment



■ **Non-metallic** 668 Black



■ **Non-metallic** 300 Alpine White<sup>1</sup>



□ **Metallic** A96 Mineral White<sup>2</sup>

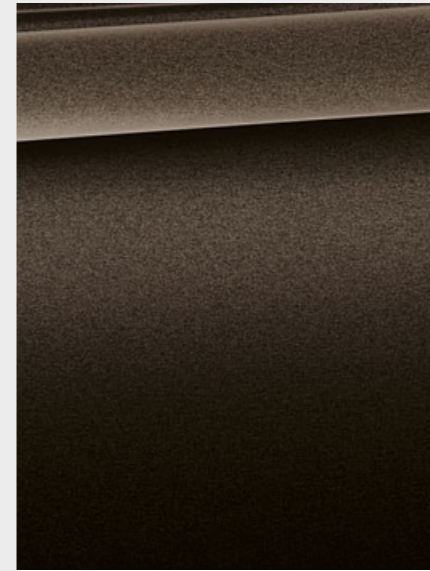

□ **Metallic** B65 Jatoba



□ **Metallic** C2S Jucaro Beige

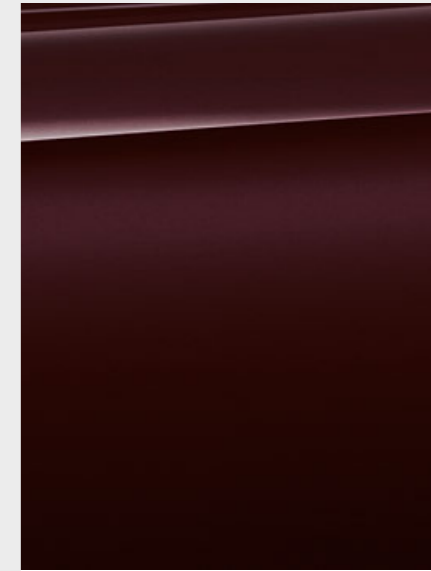

□ **Metallic** C25 Royal Burgundy Red brilliant effect<sup>2</sup>



□ **Metallic** A83 Glacier Silver

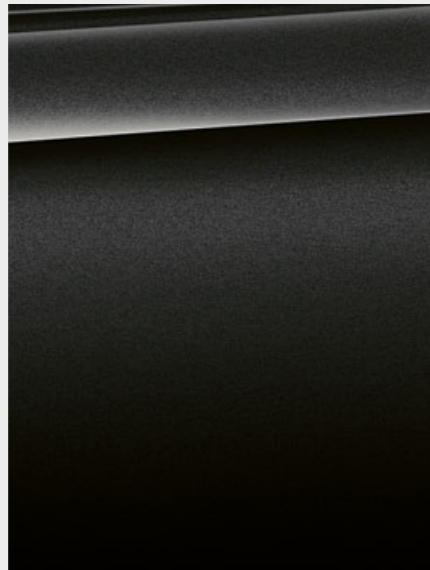

□ **Metallic** A90 Sophisto Grey Brilliant Effect<sup>2</sup>

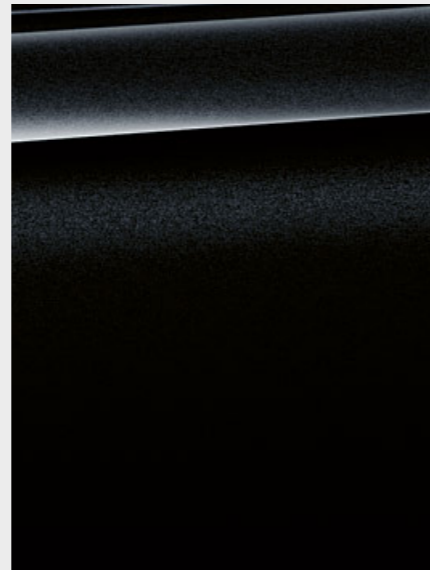

□ **Metallic** 475 Black Sapphire

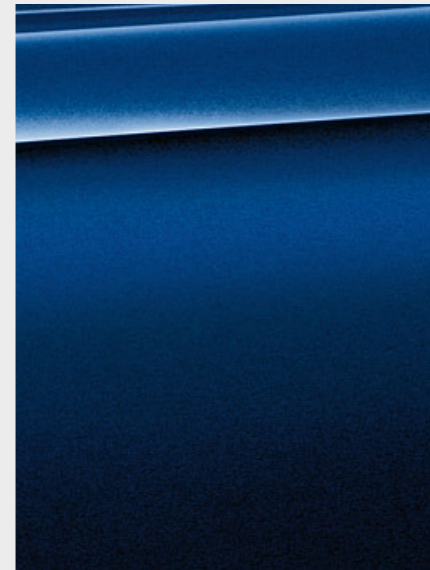

□ **Metallic** C10 Mediterranean Blue

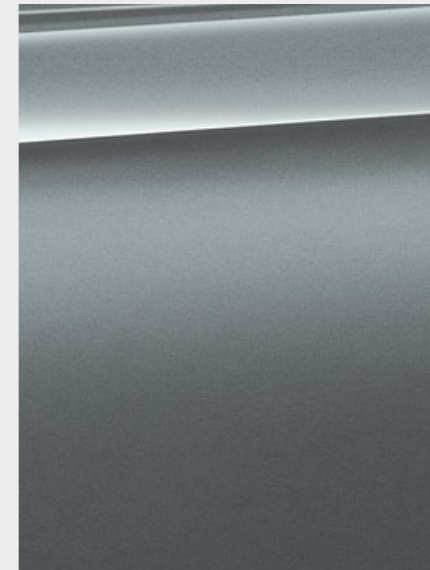

□ **Metallic** C2Y Bluestone<sup>2</sup>

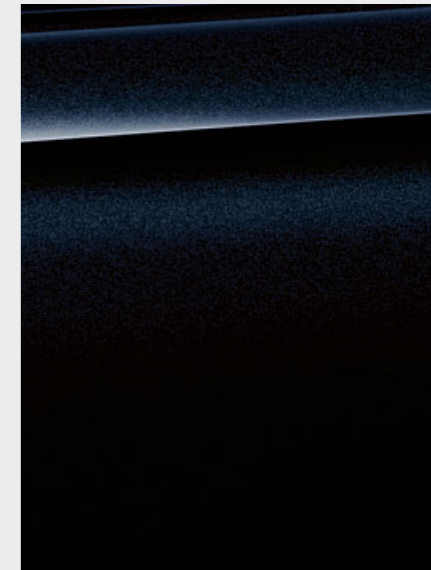

□ **Metallic** M416 Carbon Black

## M SPORT PACKAGE

[ Colours ] The colours printed above are intended to provide you with a first impression of paints and materials available for your BMW. Experience has shown, however, that printed images of paint, upholstery and interior trim colours cannot faithfully reproduce the actual

appearance of the originals. We recommend therefore that you consult your BMW partner who will be able to show you original samples and assist with special requests.

<sup>1</sup> Standard with the M Sport package.

<sup>2</sup> Also optionally available with the M Sport package.

Optional and standard equipment vary according to country.



# INTERIOR COLOURS.

Discover more with the new BMW catalogue app. Now available for your smartphone and tablet.

■ Standard equipment □ Optional equipment

## LEATHER

Available with



- Base
- Luxury Line
- Sport Line
- M Sport package

**Dakota Leather**  
LCSW Black, interior colour Black

## LEATHER

Available with

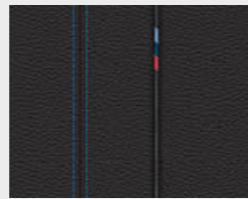

- M Sport package

**Dakota Leather**  
LCNL Black, contrast stitching blue, interior colour Black

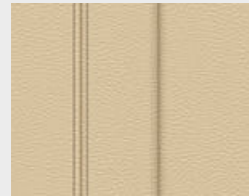

- Base
- Luxury Line
- Sport Line
- M Sport package

**Dakota Leather**  
LCCY Canberra Beige, interior colour Canberra Beige



- Luxury Line
- Sport Line
- M Sport package

**Exclusive Nappa leather** LZFK Black exclusive stitching<sup>1</sup>/leather piping in contrast, interior colour Black

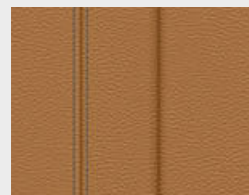

- Base
- Luxury Line
- Sport Line
- M Sport package

**Dakota Leather**  
LCRI Cognac, interior colour Black

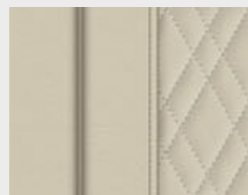

- Luxury Line
- Sport Line
- M Sport package

**Exclusive Nappa leather** LZFI Ivory White exclusive stitching<sup>1</sup>/leather piping in contrast, interior colour Black

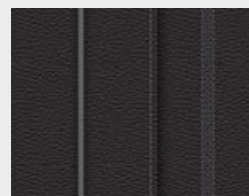

- Luxury Line
- Sport Line
- M Sport package

**Dakota Leather**  
LCFK Black exclusive stitching<sup>1</sup>/leather piping in contrast Black

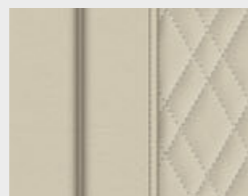

- Luxury Line
- Sport Line
- M Sport package

**Exclusive Nappa leather** LZFF Ivory White exclusive stitching<sup>1,2</sup>/leather piping in contrast, interior colour Black

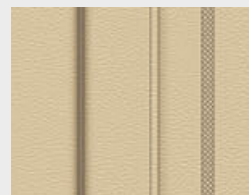

- Luxury Line
- Sport Line
- M Sport package

**Dakota Leather**  
LCDO Canberra Beige exclusive stitching<sup>1</sup>/leather piping in contrast, interior colour Canberra Beige

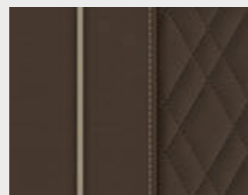

- Luxury Line
- Sport Line
- M Sport package

**Exclusive Nappa leather** LZNI Mocha exclusive stitching<sup>1</sup>/leather piping in contrast, interior colour Black

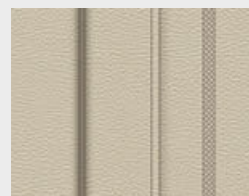

- Base
- Luxury Line
- Sport Line
- M Sport package

**Dakota Leather**  
LCFI Ivory White, exclusive stitching<sup>1</sup>/leather piping in contrast, interior colour Black

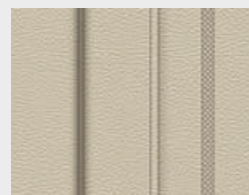

- Luxury Line
- Sport Line
- M Sport package

**Dakota Leather**  
LCFF Ivory White, exclusive stitching<sup>1</sup>/leather piping in contrast, interior colour Black

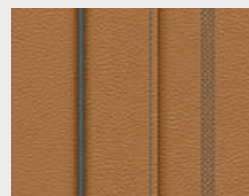

- Luxury Line
- Sport Line
- M Sport package

**Dakota Leather**  
LCRO Cognac exclusive stitching<sup>1</sup>/leather piping in contrast, interior colour Black

## INTERIOR TRIMS

Available with



- Base
- Luxury Line
- Sport Line
- M Sport package

Interior trim finishers Oxide Silver dark matt with highlight trim finisher Pearl Chrome



- M Sport package

Interior trim finishers Aluminium Rhombicle with highlight trim finisher Pearl Chrome



- Base
- Luxury Line
- Sport Line
- M Sport package

Interior trim finishers Aluminium fine cutting with highlight trim finisher Pearl Chrome

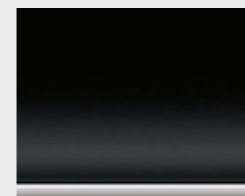

- Base
- Luxury Line
- Sport Line
- M Sport package

Interior trim finishers black high-gloss with highlight trim finishers Pearl Chrome



- Base
- Luxury Line
- Sport Line
- M Sport package

Open-pored fine-wood trim 'Fineline' Cove with highlight trim finisher Pearl Chrome

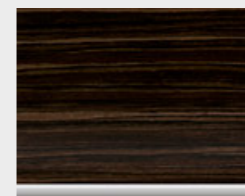

- Base
- Luxury Line
- Sport Line
- M Sport package

Fine-wood trim 'Fineline' Ridge with highlight trim finisher Pearl Chrome

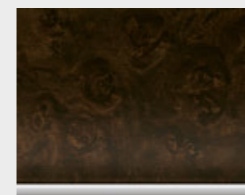

- Base
- Luxury Line
- Sport Line
- M Sport package

Fine-wood trim dark burled walnut with highlight trim finisher Pearl Chrome

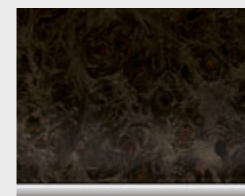

- Base
- Luxury Line
- Sport Line
- M Sport package

Fine-wood trim poplar grain grey with highlight trim finisher Pearl Chrome

## INTERIOR TRIMS

Available with



- Base
- Luxury Line
- Sport Line
- M Sport package

Interior trim finishers in BMW Individual piano finish Black with highlight trim finisher Pearl Chrome

## INTERIOR COLOURS

Available with

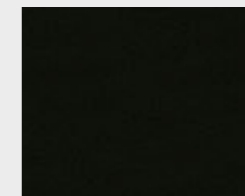

- Base
- Luxury Line
- Sport Line
- M Sport package

Black

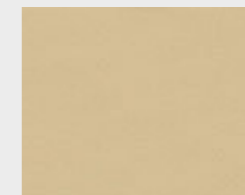

- Base
- Luxury Line
- Sport Line
- M Sport package

Canberra Beige

Please note that even normal long- or short-term use can lead to unrecoverable upholstery damage. This can be caused in particular by non-colourfast clothing.

<sup>1</sup> Only available in conjunction with instrument panel in Sensatec.  
<sup>2</sup> Only available in conjunction with comfort seats.

Optional and standard equipment vary according to country.

Please note that the interior colour depends on the selected upholstery colour.



# WHEELS AND TYRES.

Discover more with the new BMW catalogue app. Now available for your smartphone and tablet.



□ 20" light alloy wheels V-spoke style 628 Bicolour with mixed tyres and run-flat properties, front 8.5J x 20 with 245/40 R20 tyres, rear 10J x 20 with 275/35 R20 tyres.



□ 19" light alloy wheels V-spoke style 620, 8.5J x 19 with 245/45 R19 tyres.



■ 17" light alloy wheels V-spoke style 618, 7.5J x 17 with 225/60 R17 tyres.



■ 17" light alloy wheels turbine style 645 in Bicolour Orbit Grey, gloss-lathed, BMW EfficientDynamics, 7.5J x 17, with 225/60 R17 tyres.



□ 18" light alloy wheels Multi-spoke style 619, 8J x 18 with 245/50 R18 tyres.



□ 18" light alloy wheels V-spoke style 684 Ferric Grey gloss-lathed, 8J x 18 with 245/50 R18 tyres.

# ORIGINAL BMW ACCESSORIES.

Equipment 40 | 41

■ Standard equipment □ Optional equipment ○ Accessories



○ The Pro 2.0 rear bicycle rack is lightweight yet sturdy and can carry up to 60 kg. Exceptionally easy to use, it carries two bicycles or e-bikes (can be extended to accommodate three bicycles). Its tilt function also allows easy access to the luggage compartment at all times.



○ This contemporary roof box in Black with titanium silver side trims has a 520-litre capacity and fits all BMW roof rack systems. It can be opened from both sides and features triple central locking on each side which makes it easy to load and provides anti-theft locking.

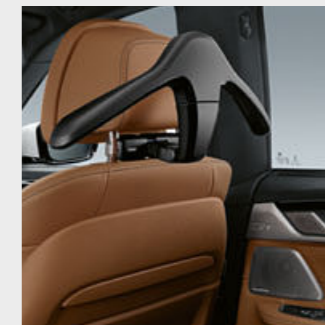

○ The coat hanger slots into the separately available base (required) and can also be used outside the vehicle.



○ Secure base for the Apple iPad® 2, 3 or 4. The holder is snapped into the basic carrier and can be rotated 360° as well as tilted to the desired angle.



○ The premium-quality 21" light alloy wheels are in bicolour Black, gloss-lathed on the visible side, and feature a weight-optimised, rolled-steel rim bed. Complete wheel set with run-flat mixed tyres, wheel size 8.5J x 21 with tyre size 245/35 R21 96Y XL RSC in front and 10J x 21 with tyre size 275/30 R21 98Y XL RSC rear.



○ Precisely-fitted, durable, anti-slip, water-resistant luggage compartment mat. Black with the number 5 featured as a stainless steel inlay.



BMW 6 Series GRAN TURISMO		630i <sup>7</sup>	640i <sup>7</sup> 640i xDrive <sup>7</sup>	630d* 630d xDrive*	640d xDrive*
<b>Weight</b>					
Unladen EU <sup>1</sup>	kg	1795	1845	1900	-
Unladen EU (xDrive) <sup>1</sup>	kg	-	1910	1955	2010
Max. permissible	kg	2380	2450	2510	-
Max. permissible (xDrive)	kg	-	2515	2580	2615
Permitted load	kg	660	660	680	-
Permitted load (xDrive)	kg	-	660	680	680
Permitted trailer load, unbraked <sup>2</sup>	kg	750	750	750	-
Permitted trailer load, unbraked (xDrive) <sup>2</sup>	kg	-	750	750	750
Permitted trailer load, braked, max. 12% gradient/max. 8% gradient <sup>2</sup>	kg	2100/- <sup>3</sup>	2100/- <sup>3</sup>	2100/- <sup>3</sup>	-
Permitted trailer load, braked, max. 12% gradient/max. 8% gradient (xDrive) <sup>2</sup>	kg	-	2100/- <sup>3</sup>	2100/- <sup>3</sup>	2100/- <sup>3</sup>
Luggage compartment capacity	l	610-1800	610-1800	610-1800	610-1800
<b>Engine</b>					
Cylinders/valves		4/4	6/4	6/4	6/4
Capacity	cc <sup>3</sup>	1998	2998	2993	2993
Rated output/rated engine speed	kW (hp)/rpm	190 (258)/5000-6500	250 (340)/5500-6500	195 (265)/4000	235(320)/4400
Max. torque/engine speed	Nm/rpm	400/1550-4400	450/1380-5200	620/2000-2500	680/1750-2250
<b>Power transmission</b>					
Drive configuration		Rear-wheel/all-wheel	Rear-wheel/all-wheel	Rear-wheel/all-wheel	All-wheel
Standard transmission		Eight-speed Steptronic	Eight-speed Steptronic	Eight-speed Steptronic	-
Standard transmission (xDrive)		-	Eight-speed Steptronic	Eight-speed Steptronic	Eight-speed Steptronic
<b>Performance</b>					
Top speed	km/h	250 <sup>4</sup>	250 <sup>4</sup>	250 <sup>4</sup>	-
Top speed (xDrive)	km/h	-	250 <sup>4</sup>	250 <sup>4</sup>	250 <sup>4</sup>
Acceleration 0-100 km/h	s	6.3	5.4	6.1	-
Acceleration (xDrive) 0-100 km/h	s	-	5.3	6.0	5.3
<b>Consumption<sup>5,6</sup> - All engines conform to the EU6 standard</b>					
Urban	l/100 km	7.8-8.2	9.6-9.8	6.7-6.9	-
Urban (xDrive)	l/100 km	-	10.5-11.1	6.7-7.1	7.0-7.2
Extra urban	l/100 km	5.3-5.8	5.4-6.0	4.8-5.1	-
Extra-urban (xDrive)	l/100 km	-	6.1-6.5	5.0-5.3	5.3-5.5
Combined	l/100 km	6.2-6.6	7.0-7.4	5.5-5.8	-
Combined (xDrive)	l/100 km	-	7.7-8.2	5.7-5.9	5.9-6.1
Exhaust emissions standard (type-certified)		EU6	EU6	EU6	EU6
CO <sub>2</sub> emissions, combined	g/km	142-152	159-169	146-152	-
CO <sub>2</sub> emissions, combined (xDrive)	g/km	-	177-187	151-156	155-161
Tank capacity (approx.)	l	68	68	66	66
<b>Wheels/tyres</b>					
Tyre dimensions		225/60 R17 99 Y	225/60 R17 99 Y	225/60 R17 99 Y	225/60 R17 99 Y
Wheel dimensions		7,5 J x 17	7,5 J x 17	7,5 J x 17	7,5 J x 17
Material		Light alloy	Light alloy	Light alloy	Light alloy

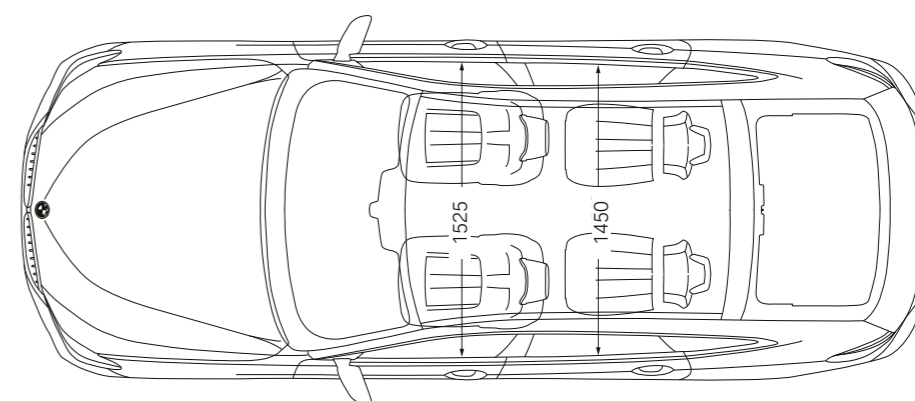
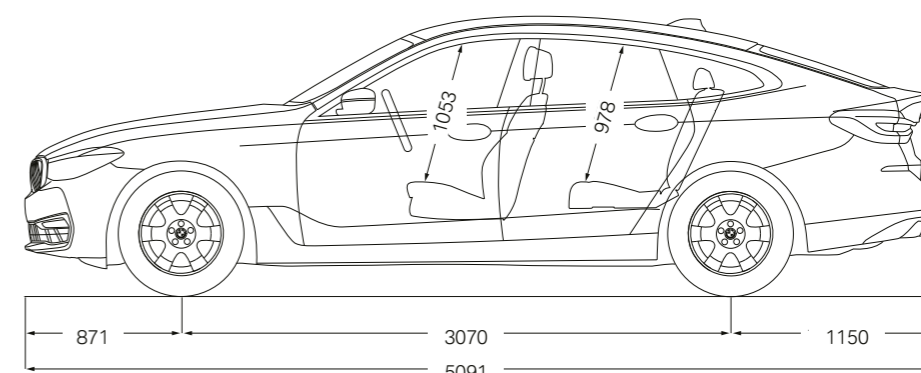
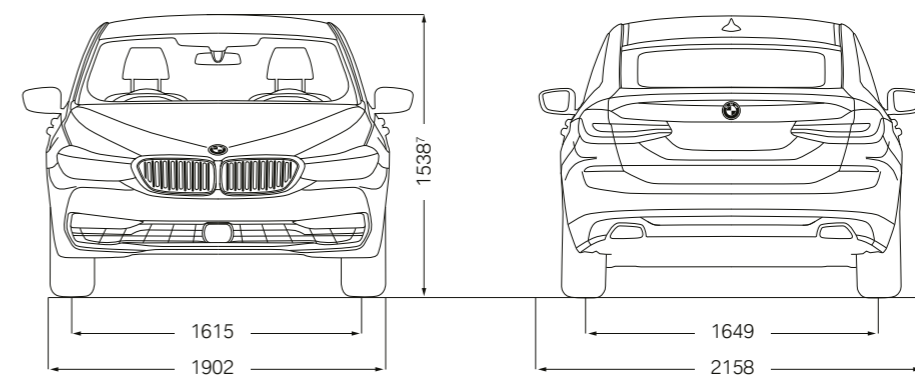

All dimensions in the technical drawings are given in millimetres. Quoted performance, fuel consumption and CO<sub>2</sub> emissions figures refer to vehicles with standard transmission. Figures in [ ] refer to vehicles with Steptronic transmission.

<sup>1</sup> The EC unladen weight refers to a vehicle with standard equipment and does not include any optional extras. The unladen weight includes a 90% full tank and a driver weight of 75 kg. Optional equipment may affect the weight of the vehicle, the payload and the top speed if the selected equipment has an impact on the vehicle's aerodynamics.

<sup>2</sup> The actual total weight of the trailer must not exceed the maximum permitted trailer load, taking into account the maximum tow bar download.

<sup>3</sup> Provisional figures; any missing figures were unavailable at the time of publication.

<sup>4</sup> Electronically limited.

<sup>5</sup> Performance data of petrol engines apply to vehicles using RON 98 fuel. Fuel consumption data apply to vehicles using reference fuels in accordance with EU Regulation 2007/715. Unleaded RON 91 and higher with a maximum ethanol content of 10% (E10) may also be used. BMW recommends RON 95 super unleaded petrol.

<sup>6</sup> The data for fuel consumption, CO<sub>2</sub> emissions and energy consumption are determined in accordance with the measurement processes as defined by European Regulation (EC) 715/2007 in the applicable version. Data refer to a vehicle with base-level equipment in Germany, and the ranges account for differences according to the selected wheel and tyre size and the optional equipment and may change during the configuration process. Data for vehicles indicated with \* have already been determined on the basis of the new WLTP test cycle and adjusted for comparability with NEDC.

<sup>7</sup> Models/engines for which these values apply can be ordered until 04/15/2018. Please ask your BMW Partner for more detailed information about the availability.

<sup>8</sup> BMW 640i xDrive and BMW 630d xDrive: 1,540 mm.



**BMW 640i xDRIVE GRAN TURISMO WITH M SPORT PACKAGE:**

BMW TwinPower Turbo inline 6-cylinder petrol engine, 250kW (340hp), 20" BMW M light alloy wheels Double-spoke style 648 M Bicolour with mixed tyres, exterior colour in Mineral White metallic, comfort seats in leather ‚Dakota‘ Cognac with exclusive stitching and contrast piping, BMW Individual interior trim finisher in piano finish Black with highlight trim finisher in Pearl Chrome, instrument panel in Sensatec Black.

The models illustrated in this brochure show the equipment and configuration options (standard and optional) for vehicles produced by BMW AG for the German market. Alterations in standard and optional equipment and the configurations available for the different models, as described in this brochure, may occur after 16/11/2017, the date when this brochure went to press, or according to the specific requirements of other markets. Your local BMW Partner is available to provide further details. Subject to change in design and equipment.

© BMW AG, Munich, Germany. Reproduction, even in part, only with the written approval of BMW AG, Munich.

411 006 148 20 1 2018 BM. Printed in Germany 2018.

