



Sheer
Driving Pleasure



THE NEW BMW 3 SERIES SALOON.

BMW EFFICIENT DYNAMICS.
LESS EMISSIONS. MORE DRIVING PLEASURE.

THE NEW BMW 3 SERIES SALOON.



INNOVATION AND TECHNOLOGY.



18 Dynamics and efficiency
19 Powertrain and suspension



20 Driver assistance
21 Safety



22 Connectivity and infotainment
23 Comfort and functionality

EQUIPMENT.



24 Models and Lines

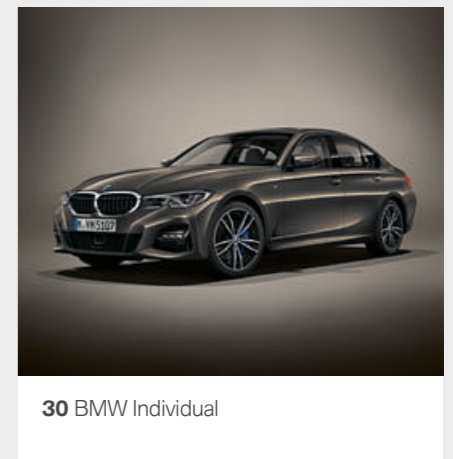

30 BMW Individual



32 Additional equipment

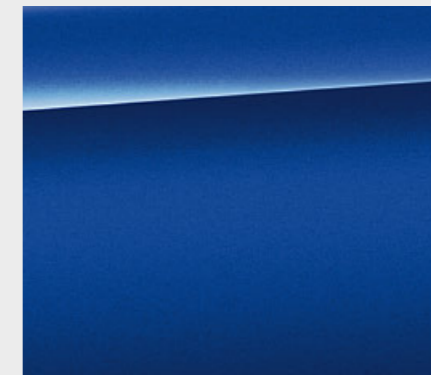

36 Exterior colours

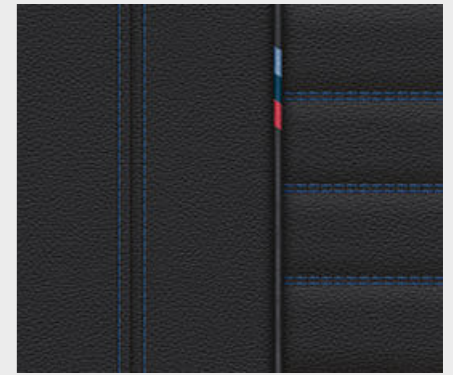

38 Interior colours

DIGITAL DISCOVERY: THE NEW BMW BROCHURES APP.



More information, more driving pleasure: The new BMW brochures app offers you a brand new digital and interactive BMW experience. Download the BMW brochures app for your smartphone or tablet now and explore new perspectives of your BMW.



40 Wheels and tyres



41 Original BMW Accessories

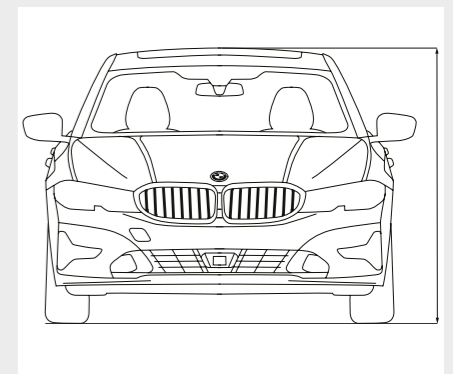

42 Technical data



A CAR
MOVES
YOU.
**A BMW
TOUCHES
YOU.**



THE ONLY THING THAT KEEPS
PACE IS YOUR EXCITEMENT.



WE HAVE PUT IN
THE VERY BEST.
BRING IT OUT.

IT ATTRACTS.
ESPECIALLY LOOKS.





READY FOR A
TRAILBLAZER.



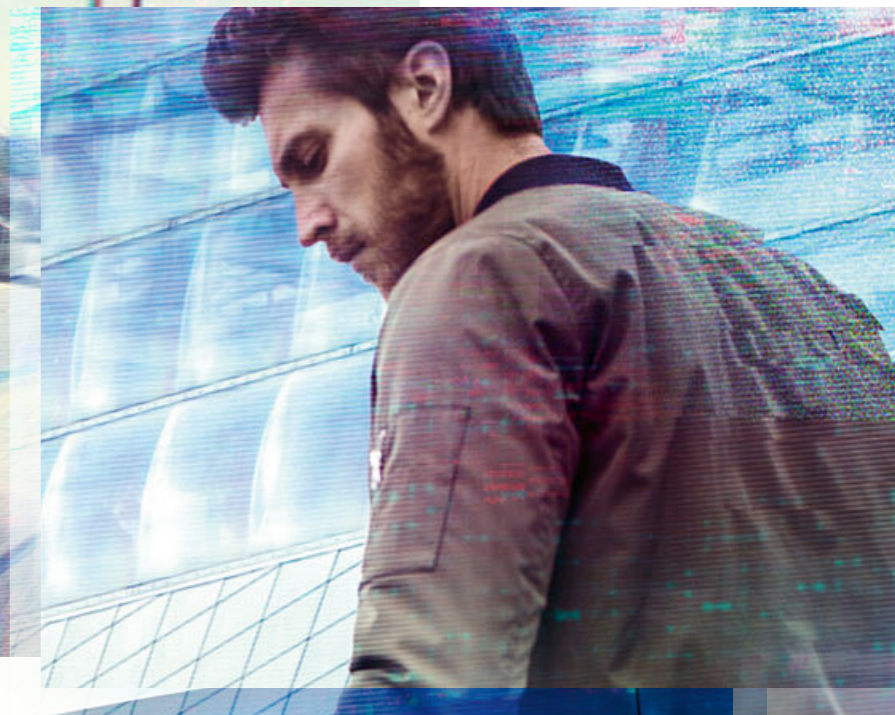

LEAVE A MARK.
TAKE AWAY IMPRESSIONS.

THE MOST BEAUTIFUL EXPECTATIONS:
THE EXCEEDED ONES.



Timeless athleticism sporty proportions with optimal aerodynamics II BMW Laserlight¹ II LED rear lights II 19" light alloy wheels.¹ **Next-level driver assistance and connectivity** BMW Intelligent Personal Assistant² II Driving Assistant Professional¹ with extensive safety and comfort features II Parking Assistant Plus¹ II Customisable BMW Live Cockpit Professional^{1,3} with a display network consisting of a 12.3" fully digital instrument display and a 10.25" Control Display II Digital Key.⁴ **Comfortable equipment** Ambient light including Welcome Light Carpet¹ II Improved interior acoustics. **Outstanding driving dynamics** BMW M340i xDrive Saloon⁶ II M Sport differential^{1,5} II Adaptive M suspension¹ II Active air stream kidney grille II Efficient Lightweight. **An icon on the way to the future – the new BMW 3 Series Saloon.**

¹ Available as optional equipment.

² Part of the BMW Live Cockpit Professional equipment.

³ Only available in conjunction with additional equipment.

⁴ Part of the Comfort access package.

⁵ Standard for M340i xDrive.

⁶ Available from 07/19.

BMW EFFICIENT DYNAMICS.
LESS EMISSIONS. MORE DRIVING PLEASURE.



AERODYNAMICS

■ Thanks to targeted aerodynamic measures, every BMW boasts excellent air resistance figures. This has a positive impact on efficiency and driving stability, and reduces the level of noise in the interior. This is thanks to sophisticated solutions such as the Active air stream kidney grille, the flat underbody cover, the Air Blades on the rear or the Air curtain in the front apron.

ACTIVE AIR STREAM KIDNEY GRILLE

■ The Active air stream kidney grille opens and closes the air vents in the radiator grille according to the cooling requirements of the engine and the air conditioning. The movable vents are located behind the kidney grille slats and at the same time reduce air resistance when closed, thereby improving aerodynamics.

STEPTRONIC SPORT TRANSMISSION

□ The 8-speed Steptronic Sport transmission¹ offers incredibly sporty gear changes. Whether automatic or manual using gearshift paddles or gear lever – for comfortable coasting or incredibly dynamic driving. In SPORT mode and with the gear lever in the left-hand S/M position, the gear shifts are configured for the best performance.

DRIVING EXPERIENCE CONTROL

■ The Driving Experience Control offers the driver the choice between the standard COMFORT mode, ECO PRO Mode, geared towards efficiency, and SPORT² mode, which enables even more dynamic driving. The new optional interactive function Adaptive Mode³ continuously adjusts the Dynamic Damper Control, the steering and the Steptronic transmission to suit the current driving situation.

BRAKE ENERGY REGENERATION

■ With Brake Energy Regeneration, the alternator generates electricity primarily when the driver brakes or takes their foot off the accelerator. Previously unused kinetic energy is thereby transformed into electrical energy and fed into the battery.

INTELLIGENT START/STOP FUNCTION

□ The Intelligent Auto Start Stop function⁴ uses data from the navigation system, camera and radar-based systems to analyse the current traffic situation. If it is detected that further travel is imminent (e.g. during a turning manoeuvre), the engine is not automatically switched off when the vehicle stops.

■ Standard equipment □ Optional equipment

□ The lowered **Adaptive M suspension**^{4,5} with variable shock absorber adjustment offers the choice between comfortable and sporty suspension design.

□ The **Variable sport steering**⁴ including Servotronic continuously adjusts the steering effort required and steering force depending on the current speed and on the angle of the steering wheel.

□ The **M Sport suspension**⁴ is set approximately 10mm lower and features more athletic settings.

□ The **M sport differential**^{4,6} optimises traction and driving stability when driving dynamically or on different road surfaces.

□ The powerful **M Sport brake**^{1,4} features large brake discs and exclusive blue-painted brake callipers with the M logo.

□ For maximum traction, driving dynamics and safety, the **BMW xDrive all-wheel drive system** provides variable drive power distribution to the front and rear axles.

ENGINE HIGHLIGHTS OF THE NEW BMW 3 SERIES SALOON.

BMW M340i xDrive^{7,8}
BMW TwinPower Turbo 6-cylinder petrol engine with 275 kW (374 hp) and 500 Nm torque
Acceleration 0–100 km/h: 4.4 s
top speed: 250 km/h⁹
Combined fuel consumption: [7.5]l/100 km
Combined CO₂ emissions: [172]g/km

BMW 320d xDrive
BMW TwinPower Turbo 4-cylinder diesel engine with 140 kW (190 hp) and 400 Nm torque
Acceleration 0–100 km/h: 6.9 s
top speed: 233 km/h
Combined fuel consumption: 4.5–4.8l/100 km
Combined CO₂ emissions: [118–125]g/km



¹ Standard for M340i xDrive.
² SPORT+ mode available for 330i, 330d and M340i xDrive.
³ The Adaptive Mode function is available only in conjunction with the Adaptive M suspension equipment.
⁴ Only available in conjunction with additional equipment.

⁵ 330e without lowering.
⁶ Standard for M340i xDrive and optionally available for 330i.
⁷ Expected to be available from 07/2019.
⁸ Provisional figures; any missing figures were unavailable at the time of publication.
⁹ Electronically limited.

The data for fuel consumption, CO₂ emissions and energy consumption are determined in accordance with the measurements processes as defined by European Regulation (EU) 2007/715 in the applicable version. Data refer to a vehicle with base-level equipment in Germany, and the ranges account for differences according to the selected wheel and tyre size and the optional equipment and may change during the configuration process. Figures have been determined on the basis of the new WLTP test cycle and have been converted back into NEDC figures for comparability. The Standard and Optional equipment may differ between countries. Please consult your local BMW partner for more information.

DRIVER ASSISTANCE.

BMW Personal CoPilot By your side, when you decide.

□ **Driving Assistant Professional¹** offers optimum comfort and maximum safety during lots of critical or monotonous driving situations with Steering and lane control assistant, local Hazard warning¹, Lane Keeping Assistant with active side collision protection and other safety functions.

□ **Active cruise control with Stop&Go function^{1,2}** maintains a pre-defined distance from the car ahead, including stopping and restarting in stop-and-go traffic. Speed Limit Assist allows the takeover of speed limits in the cruise control. The approach control warning with braking function reacts to stationary vehicles, pedestrians and cyclists.

□ The **Steering and lane control assistant³** can be activated to support you in monotonous traffic situations. At speeds of up to 210 km/h on all road surfaces with Active cruise control, the system conveniently supports steering and keeps the vehicle in the centre of its lane.

□ **Parking Assistant Plus¹** makes parking and manoeuvring the vehicle easier. It features among others the Surround View system including Top View, Panorama View and Remote View 3D, as well as a lateral parking aid, the Parking Assistant with linear guidance and Reversing Assistant.

□ The **Lateral parking aid⁴** is a part of Park Distance Control and gives you an "all-round view" near the vehicle during manoeuvring. In this way, obstacles on the sides of the vehicle are detected and signalled audibly and visually.

□ The **Reversing Assistant⁴** stores the last 50 m of the driven path in forward travel up to 35 km/h, so that it can be retracted if required. You are relieved of the steering work and can concentrate on monitoring the vehicle environment.



¹ Only available in conjunction with additional equipment.
² Also part of the Driving Assistant Professional package.
³ Part of the Driving Assistant Professional package.
⁴ Part of the Parking Assistant or Parking Assistant Plus packages.

SAFETY.

■ Standard equipment □ Optional equipment

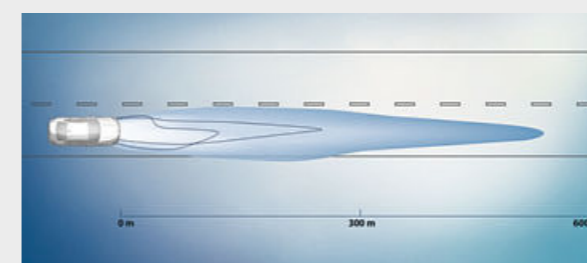

□ The **Adaptive BMW Laserlight** extends the maximum illumination range in high-beam mode to up to 530 m.



□ The **Crossing traffic warning rear⁵** warns you of crossing traffic when pulling out of perpendicular parking spaces.



■ **Active Guard Plus** includes front collision warning with braking function, Lane Departure Warning and Speed Limit Info including manual Speed Limit Assist.

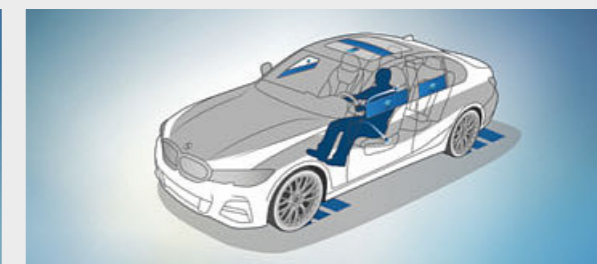

□ **Active Protection** takes precautions in critical situations and brakes the car to a standstill after an accident.

⁵ Part of the Driving Assistant and Driving Assistant Professional packages.

The Standard and Optional equipment may differ between countries. Please consult your local BMW partner for more information.

CONNECTIVITY AND INFOTAINMENT.

BMW ConnectedDrive Connected to be free.



BMW INTELLIGENT PERSONAL ASSISTANT

□ 'Hello, BMW. Who are you?' Wouldn't it be incredible if your BMW acted like your personal assistant? Communicate in a new and easy way with your vehicle using the BMW Intelligent Personal Assistant^{1,2}. It knows you, learns your behaviours to improve every day and helps out whatever the situation. It can explain everything about your vehicle and help you get better acquainted with your BMW. You can even assign your own personal activation word.

CONNECTED PACKAGE PROFESSIONAL

□ Should you get Concierge Services, Remote Services or the Connected Navigation services of Real Time Traffic Information and Parking Space Assistant? Why choose individual options when you can have everything? With the Connected Package Professional², you can enjoy these services from BMW ConnectedDrive as well as free additional services to test. The term is three years.

IN-CAR EXPERIENCES

□ Your BMW will take care of you. It invigorates you when you are tired, relaxes you after a stressful day and adapts your vehicle's interior to perfectly suit your mood. With In-Car Experiences^{1,2}, which include the Caring Car Programmes and Experiences Modes, your vehicle will make sure you feel your best.

BMW LIVE COCKPIT PROFESSIONAL

□ The BMW Live Cockpit Professional² with navigation function includes a high-quality display network consisting of a high-resolution 10.25" Control Display that can be operated by touch and a fully digital 12.3" instrument display. The BMW Operating System 7.0 can also be operated via the iDrive Controller.

DIGITAL KEY

□ Why put your key in the ignition if you have your Android smartphone with you? The Digital Key^{3,4,5} allows you to lock and unlock your BMW and even start the engine without needing a physical key. It can be downloaded to your Android smartphone using the BMW Connected app and shared with family and friends. The term is one year.

REMOTE SOFTWARE UPGRADE

□ Do you want your BMW to be up to date with the latest software? With Remote Software Upgrade⁶, your BMW will always be like new. Convenient, reliable and stress-free – without having to visit your BMW service partner. Upgrades are installed over-the-air, just as they are for your smartphone.

¹ Part of the Connected Package Professional equipment.

² Only available in conjunction with additional equipment.

³ Part of the Comfort access package.

⁴ Only available in conjunction with Steptronic transmission.

⁵ Momentarily only possible with selected Samsung smartphone models and from Android 8.0 onwards in specific markets. Available for various BMW models from production period 07/2018 onwards.

⁶ This option is only available in conjunction with BMW Live Cockpit Professional.

COMFORT AND FUNCTIONALITY.

■ Standard equipment □ Optional equipment

□ **Contactless opening and closing of the tailgate^{3,7}** is part of the Comfort access system. In situations where the user's hands are full, all that's necessary is a targeted motion of the foot under the rear bumper and the process is carried out conveniently and automatically. They just need to be carrying the car key with them.

□ **Automatic tailgate operation** allows the convenient opening and closing of the tailgate by simply pressing the button located in easy reach in the door panelling or on the car key. The tailgate can also be opened in the conventional manner, using the outside handle, and closed pressing a button on the inside of the tailgate.

□ **Folding headrests** for the three rear seats provide a better view through the rear window. They make it much easier for the driver to park and manoeuvre when space is limited, and also provide a better view of the traffic behind.

□ Even before the engine has reached its running temperature, the **seat heating for driver and front passenger** provides pleasant warmth, adjustable in three levels. The heat elements warm the surface of the seat, the side bolsters, and the entire contact surface of the backrest.

□ **Ambient light**, including Ambient contour lighting in the front and rear doors, creates a relaxed, cosy lighting atmosphere in the interior. The Welcome Light Carpet illuminates the area in front of the car doors when entering and exiting. Six dimmable light designs in White, Blue, Orange, Bronze, Lilac and Green are available.

□ The **acoustic glazing** on the front side windows complements the acoustic glazing on the front windscreen and significantly reduces the level of noise for everyone inside the vehicle. It minimises noise created by the outside surroundings and flow of air, as well as by the engine, tyres and windscreen wipers. Music listeners and hands-free device users in particular will appreciate the difference this makes.



⁷ Contactless opening and closing of the tailgate only in combination with Automatic tailgate operation.

Some ConnectedDrive Services may differ between countries. Please consult your local BMW partner for more information.

The Standard and Optional equipment may differ between countries. Please consult your local BMW partner for more information.

BASE.

Discover even more with the new BMW Brochures app. Available now, for your smartphone and tablet.

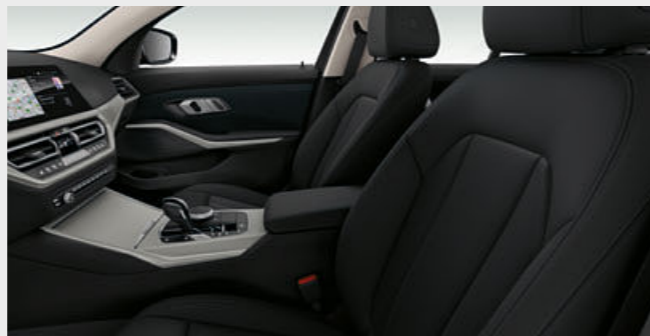

■ The black Sport leather steering wheel¹ with a thick rim and contoured thumb rests has an exceptionally pleasant, high-grip feel.

■ The standard seats for driver and front passenger can be adjusted manually in the fore-and-aft position, backrest angle, headrest height and seat angle as well as seat height. In this way, an individually tailored, comfortable position can be selected.

Selected base model equipment features:

- Multifunction buttons on the steering wheel
- Hands-free function with USB interface
- Seats in Cloth „Hevelius“
- Interior trim finishers Quartz Silver matt, grained
- Doorsill finishers with the “BMW” designation in the front, floor mats in velour
- Exterior mirrors with mirror heating
- Air conditioning
- LED headlights, rear lights with LED technology
- 16" light alloy wheels V-spoke style 774 for 320i¹, 318d¹ and 320d,
- 17" light alloy wheels V-spoke style 778 for 330i, 320d xDrive and 330e²
- Tailpipe trims, left and right
- Active Guard Plus
- BMW Live Cockpit with high-resolution touch-enabled 8.8" Control Display



■ 16" light alloy wheels V-spoke style 774 Reflex Silver, wheel size 6.5J x 16, with 205/60 R16 tyres.³



□ 18" light alloy wheels Double-spoke style 782 Bicolour Orbit Grey, gloss-lathed, 7.5J x 18 with 225/45 R18 tyres.

LUXURY LINE.

Equipment 24 | 25

■ Standard equipment □ Optional equipment

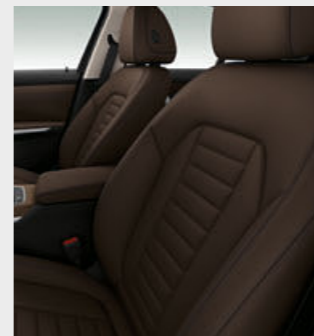

■ The black Sport leather steering wheel with a thick rim and contoured thumb rests has an exceptionally pleasant, high-grip feel.

■ The standard seats for driver and front passenger can be adjusted manually in the fore-and-aft position, backrest angle, headrest height and seat angle as well as seat height.



■ 17" light alloy wheels Double-spoke style 771 Reflex Silver, wheel size 7.5J x 17 with 225/50 R17 tyres.



□ 18" light alloy wheels Double-spoke style 781 Bicolour Ferric Grey, gloss-lathed, wheel size 7.5J x 18 with 225/45 R18 tyres.

Luxury Line exterior equipment:

- BMW kidney grille with exclusively designed vertical slats in Chrome
- Front bumper with specific design elements in black high-gloss and side air intakes in Chrome high-gloss
- 17" light alloy wheels Double-spoke style 771; other wheels available
- Mirror foot, B-pillar trim and window guide in black high-gloss
- Trim on the side window frames and window recess finishers in Chrome high-gloss
- Roof trim in body colour
- Rear bumper with side air intakes in Chrome high-gloss

Luxury Line interior equipment:

- Door sill finishers in Aluminium, in front with “BMW” designation
- Seats in leather „Vernasca“ Black with contrast stitching in Grey; other upholsteries available
- Sport leather steering wheel, □ alternatively M leather steering wheel
- Line-specific car key with Chrome detailing
- Instrument panel in Sensatec with double stitching
- Interior trim finishers in fine-wood trim Ash grey-brown high-gloss; other trims available

¹ Expected to be available from 03/2019.

² Expected to be available from 07/2019.

³ Standard for 320i, 318d and 320d.

⁴ Equipment is base in European countries. It may vary between countries. Please consult your local BMW partner for further information.

The Standard and Optional equipment may differ between countries. Please consult your local BMW partner for more information.

SPORT LINE.

Discover even more with the new BMW Brochures app. Available now, for your smartphone and tablet.



■ The black Sport leather steering wheel with a thick rim and contoured thumb rests has an exceptionally pleasant, high-grip feel.

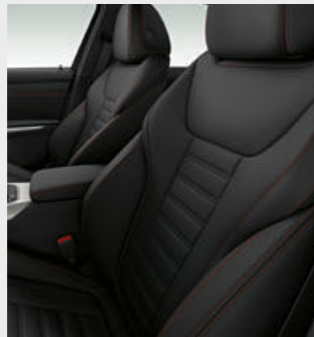

■ The Sport seats for driver and front passenger feature optimum support and various adjustment options, including backrest width.



■ 17" light alloy wheels V-spoke style 776 Ferric Grey, wheel size 7.5J x 17 with 225/50 R17 tyres.



□ 18" light alloy wheels V-spoke style 780 Bicolour Orbit Grey, gloss-lathed, wheel size 7.5J x 18 with 225/45 R18 tyres.

Sport Line exterior equipment features:

- Front bumper with specific design elements and side air intakes in black high-gloss
- 17" light alloy wheels V-spoke style 776; other wheels available
- Exterior mirror caps in body colour, alternatively in black high-gloss
- Roof trim in body colour
- BMW Individual high-gloss Shadow Line with mirror foot, B-pillar trim, window guide, window recess finisher front and rear in black high-gloss
- Rear bumper with specific design elements in black high-gloss
- Tailpipe trim in Black Chrome

Sport Line interior equipment features:

- Door sill finishers in Aluminium, in front with "BMW" designation
- Sport seats in Cloth/Sensatec combination Black with contrast stitching in Grey; other upholsteries available
- Sport leather steering wheel,
 - alternatively M leather steering wheel
- Line-specific car key with Chrome detailing
- Interior trim finishers in black high-gloss; other trims available

M SPORT PACKAGE.

Equipment 26 | 27

powered by 

■ Standard equipment □ Optional equipment



■ M Leather steering wheel including multifunction buttons, steering wheel rim in leather 'Walknappa' Black with contoured thumb rests.

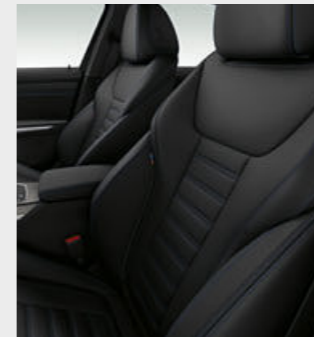

■ The Sport seats for driver and front passenger feature optimum support and various adjustment options, including backrest width.



■ 18" M light alloy wheels Double-spoke style 790 M Bicolour Orbit Grey with mixed tyres and run-flat properties, gloss-lathed, front 7.5J x 18 with 225/45 R18 tyres, rear 8.5J x 18 with 255/40 R18 tyres.



□ 19" M light alloy wheels Double-spoke style 791 M Bicolour Jet Black with mixed tyres and runflat tyres, gloss-lathed, front 8J x 19 with 225/40 R19 tyres, rear 8.5J x 19 with 255/35 R19 tyres.

M Sport package exterior equipment:

- M Aerodynamics package with front apron, side sills and rear apron in body colour with diffuser insert in Dark Shadow metallic
- BMW kidney grille with exclusively designed vertical slats in black high-gloss and grille frame in Chrome high-gloss,
 - alternatively grille frame in black high-gloss
- LED fog lights
- 18" M light alloy wheels Double-spoke style 790 M in Bicolour with mixed tyres and run-flat properties; other wheels available
- M Sport brake with blue painted brake callipers with M designation
- M Sport suspension incl. Variable sport steering; other suspensions available
- BMW Individual high-gloss Shadow Line, alternatively BMW Individual Exterior Line Aluminium satinised
- M designation on the sides
- Exterior mirror caps in body colour, alternatively in Black high-gloss
- Roof mouldings in body colour
- Tailpipe trims in Chrome high-gloss,
 - alternatively in Black high-gloss¹
- Exclusive paintwork in Portimao Blue metallic; other paintworks available

M Sport package interior equipment:

- M door sill finishers
- M driver footrest² and M pedals
- Floor mats with exclusive M designation³
- Sport seats for the driver and front passenger in Alcantara/Sensatec combination with Blue contrast stitching
- Sport seats for driver and front passenger in leather 'Vernasca' Black with contrast stitching in Blue featuring instrument panel in Sensatec with exclusive blue stitching; other upholsteries available
- M Leather steering wheel
- Car key with exclusive M designation
- BMW Individual headliner anthracite
- Instrument cluster with M specific display
- Interior trim finishers in Aluminium Tetragon, other trims available
- Shortened gear lever with exclusive M designation for manual transmission

¹ Only available in conjunction with BMW Individual high-gloss Shadow Line with extended contents.

² Only available in conjunction with interior colour Black.

³ Only available in conjunction with M specific upholsteries KGNL and MANL.

The Standard and Optional equipment may differ between countries. Please consult your local BMW partner for more information.

BMW M340i xDRIVE.

The new BMW M340i xDrive Saloon.



The M340i xDrive¹ is powered by a three-litre inline 6-cylinder petrol engine with BMW TwinPower Turbo technology. With an output of 275 kW (374 hp) and a maximum torque of 500 Nm, the M Performance model has an extremely sporty driving performance. It accelerates from 0 to 100 km/h in just 4.4 seconds.²



BMW 330e.

The new BMW 330e plug-in hybrid Saloon.



The BMW 330e¹ with its state-of-the-art plug-in hybrid drive meets the highest demands of driving dynamics and efficiency. The combination of the eDrive electric motor and four-cylinder petrol engine provides exhilarating driving performance and driving pleasure typical of the brand. In pure electric mode the vehicle is even free of local emissions on the road.



The all-digital instrument cluster³ creates an adrenaline-loaded ambience with its round instruments with exclusive "M340i" model designation, which is further enhanced by the M leather steering wheel with gearshift paddles.



The model designation of the M340i xDrive can be found on the right side of the tailgate and is designed in Cerium Grey.



The door sill finisher at the front with the "M340i" model designation conveys sporty elegance when the doors are opened.



The 8-speed Steptronic Sport transmission offers incredibly sporty gear changes. Whether automatic or manual using gearshift paddles or gear lever.

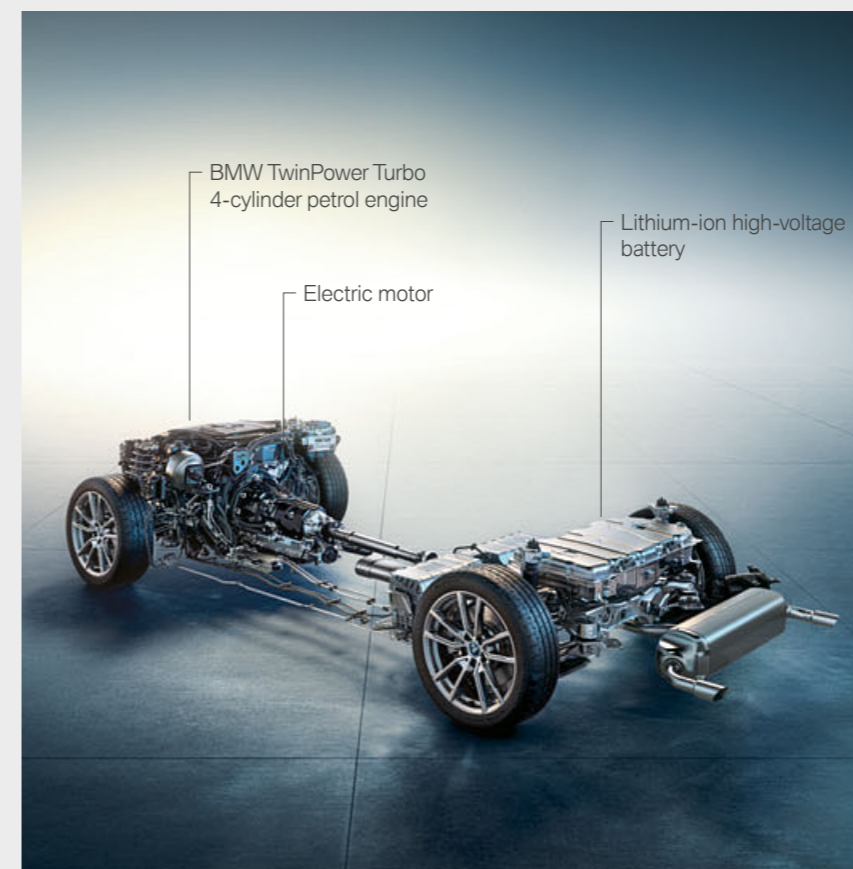

BMW TwinPower Turbo 4-cylinder petrol engine

Electric motor

Lithium-ion high-voltage battery



The display control concept of the new BMW 330e Saloon radiates Dynamic elegance, which is adapted to the innovative drive technology.



The model designation „330e“ at the rear not only draws attention to the powerful hybrid drive, but also makes the new BMW 330e Saloon stand out from the masses.

¹ Expected to be available from 07/2019.

² Provisional figures; any missing figures were unavailable at the time of publication.

³ Available as optional equipment.

The data for fuel consumption, CO₂ emissions and energy consumption are determined in accordance with the measurements processes as defined by European Regulation (EU) 2007/715 in the applicable version. Data refer to a vehicle with base-level equipment in Germany, and the ranges account for differences according to the selected wheel and tyre size and the optional equipment and may change during the configuration process.

Figures have been determined on the basis of the new WLTP test cycle and have been converted back into NEDC figures for comparability. [For these vehicles, values other than those specified here may apply for the assessment of taxes and other vehicle-related charges that are (also) based on CO₂ emissions.]

BMW INDIVIDUAL.

THE EXPRESSION OF
PERSONALITY.

THE NEW BMW 3 SERIES SALOON –
INSPIRED BY BMW INDIVIDUAL.



The BMW Individual full leather trim 'Merino' in Fiona Red/Black and the BMW Individual interior trim finishers in fine-wood trim, 'Fineline' Black with silver effect open-pored lift your new BMW 3 Series Saloon to a special level: yours.

AS UNIQUE AS YOU WANT IT TO BE.

Your special wishes, your special BMW 3 Series Saloon: BMW Individual offers you all the options to customise the new BMW 3 Series Saloon according to your personal preferences, with the degree of customisation entirely up to you. Turn the typical BMW driving pleasure into your personal driving experience and choose your favourites

from particularly high-quality paintwork, leather upholstery, interior trim finishers and light alloy wheels. Basically everything that is conceivable is possible. Or you can go your very own way, only following your ideas – we make sure that they become an automotive reality.

You are not looking for special, but unique? No matter what you are looking for, BMW Individual has the know-how and skills to make your wishes come true.

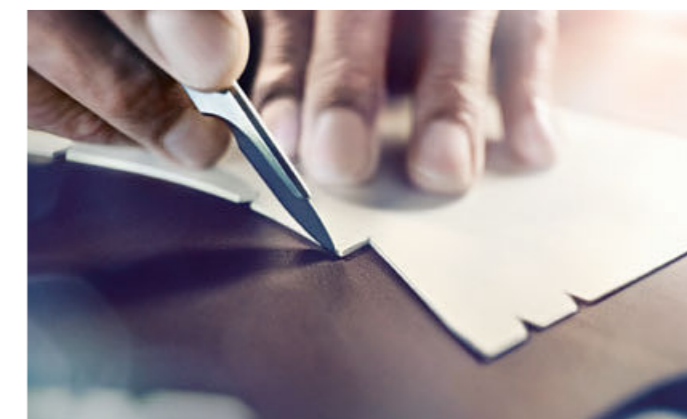

DISCOVER THE WHOLE RANGE OF BMW INDIVIDUAL EQUIPMENT FOR THIS MODEL. WITH THE BMW CATALOGUES APP FOR IOS AND ANDROID.

ADDITIONAL EQUIPMENT.

Discover even more with the new BMW Brochures app. Available now, for your smartphone and tablet.

■ Standard equipment □ Optional equipment



□ In laser high-beam mode, the Adaptive BMW Laserlight illuminates a range of up to 530m, nearly twice as far as that of conventional headlights. Better visibility in the dark significantly increases safety. Blue accents and the lettering „BMW Laser“ in the headlight also underline the technological standards and the sportiness of the vehicle.



□ The Glass roof with slide and lift function, including an electric sliding interior roof, anti-trap protection, as well as comfort opening and closing, allows the airflow to be individually regulated to create a pleasant interior climate. The integrated wind deflector prevents draughts from developing in the interior and ensures a lower level of wind noise.



□ The Adaptive LED headlights with cornering lights generate a bright and efficient bi-LED light for low and high-beam headlights. The bend lighting and cornering lights with LED technology allow for adaptive light distribution with increased side illumination for city driving. The LED daytime running lights and parking lights in the light tubes of the main headlights create a distinctive feature characteristic of a BMW.



■ The rear lights are made up of individual high-performance LED lighting elements. They have the characteristic, striking BMW L-shape, meaning that the vehicle is clearly recognisable as a BMW even in the dark.



□ Contactless opening and closing of the tailgate^{2,3} is part of the Comfort access system. In situations where the user's hands are full, all that's necessary is a targeted motion of the foot under the rear bumper and the process is carried out conveniently and automatically. They just need to be carrying the car key with them.



□ The BMW Individual Exterior Line in Aluminium satinated sets luxurious highlights with the window recess finishers and window surrounds in silk matt brushed aluminium. The B-pillar trims, the exterior mirror frames, foot and base, along with the vertical window guides, come in black high-gloss, creating a stylish contrast to these elements.



□ The tonally outstanding Harman Kardon surround sound system¹ features a 464W digital amplifier, nine channels and 16 speakers. Its sophisticated sound perfectly fills the interior space. Vehicle-specific, speed-dependent equalising precisely compensates for any background driving noise.



□ Why put your key in the ignition if you have your Android smartphone with you? The Digital Key^{2,4,5} allows you to lock and unlock your BMW and even start the engine without needing a physical key. It can be downloaded to your Android smartphone using the BMW Connected app and shared with family and friends. The term is one year.

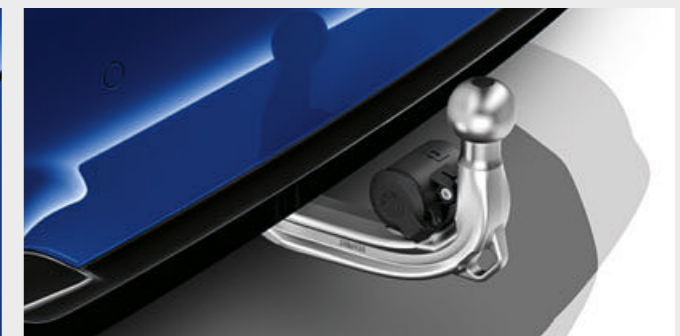

□ The trailer tow hitch with electrically adjustable tow ball is approved for heavy loads of up to 1.600 kg. In order to stabilise, the trailer stability control automatically brakes the pulling vehicle if the trailer begins to swing. The electronically adjustable tow ball is not visible when stowed under the rear apron.

¹ Only available in conjunction with additional equipment.

² Part of the Comfort access system.
³ Contactless opening and closing of the tailgate only in combination with Automatic tailgate operation.
⁴ Only available in conjunction with Steptronic transmission.
⁵ Momentarily only possible with selected Samsung smartphone models and from

Android 8.0 onwards in specific markets. Available for various BMW models from production period 07/2018 onwards.

The Standard and Optional equipment may differ between countries. Please consult your local BMW partner for more information.

ADDITIONAL EQUIPMENT.

Discover even more with the new BMW Brochures app. Available now, for your smartphone and tablet.

■ Standard equipment □ Optional equipment



□ The BMW Live Cockpit Professional¹ with navigation function includes a high-quality display network consisting of a high-resolution 10.25" Control Display that can be operated by touch and a fully digital 12.3" instrument display. The BMW Operating System 7.0 can also be operated via the iDrive Controller.



□ The BMW Live Cockpit Plus with navigation function includes an instrument panel with a 5.7" instrument cluster, a high-resolution 8.8" touch-enabled Control Display and the iDrive Touch Controller on the centre console. The BMW Operating System 6.0 can also be operated via the iDrive Controller.

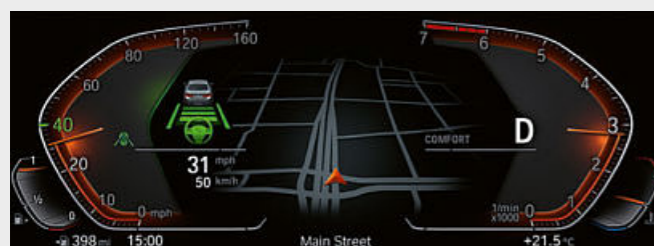

□ Driving Assistant Professional¹ offers optimum comfort and maximum safety during lots of critical or monotonous driving situations with Steering and lane control assistant, local Hazard warning, Lane Keeping Assistant with active side collision protection and other safety functions.



□ Parking Assistant Plus¹ makes parking and manoeuvring the vehicle easier. It features among others the Surround View system including Top View, Panorama View and Remote View 3D, as well as a lateral parking aid, the Parking Assistant with linear guidance and Reversing Assistant.

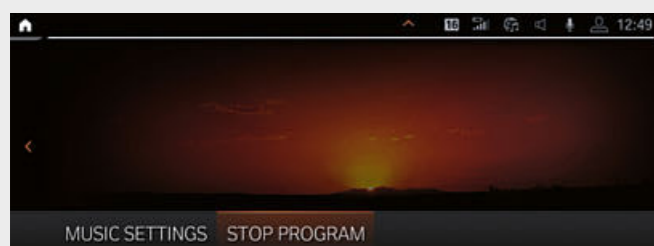

□ Your BMW will take care of you. It invigorates you when you are tired, relaxes you after a stressful day and adapts your vehicle's interior to perfectly suit your mood. With In-Car Experiences^{1,2}, which include the Caring Car Programmes and Experiences Modes, your vehicle will make sure you feel your best.

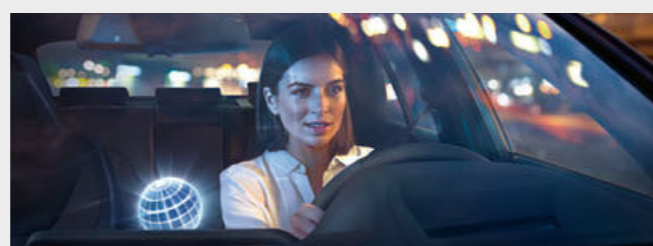

□ 'Hello, BMW. Who are you?' Wouldn't it be incredible if your BMW acted like your personal assistant? Communicate in a new and easy way with your vehicle using the BMW Intelligent Personal Assistant^{1,2}. It knows you, learns your behaviours to improve every day and helps out whatever the situation. It can explain everything about your vehicle and help you get better acquainted with your BMW. You can even assign your own personal activation word.



□ The full-colour BMW Head-Up Display^{1,3} projects all information relevant to the journey directly into the driver's field of vision.



□ Telephony with wireless charging⁴ offers a comprehensive telephony package with Bluetooth connectivity and the technical capacity for a WiFi hotspot.⁵

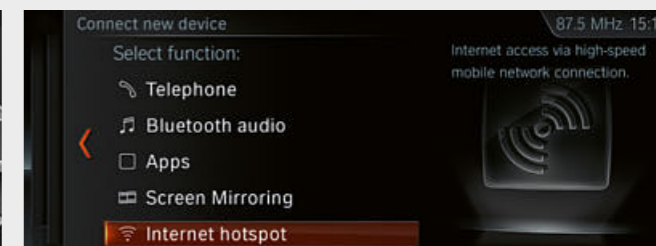

□ Take part in video conference calls on your tablet or stream the final episode of your favourite series on your smartphone. The Wi-Fi Hotspot⁵ is a way to go online with LTE speed (if available) using the SIM card installed in your vehicle. You and your fellow passengers can surf the Web on up to ten devices.



□ Concierge Service, Remote Services or Real Time Traffic Information? Why choose individual options when you can have everything together? With the Connected Package Professional, you can enjoy these services from BMW ConnectedDrive as well as free additional services to test. The term is three years.



□ The upper part of the instrument panel in Sensatec Black lends the interior of the vehicle a highly exclusive atmosphere. The wear-resistant material is finished with attractive double lap seams.



□ Ambient light, including Ambient contour lighting in the front and rear doors, creates a relaxed, cosy lighting atmosphere in the interior. The six dimmable lighting designs also include a dynamic function in four applications. The Welcome Light Carpet illuminates the area in front of the vehicle doors when getting in and out.

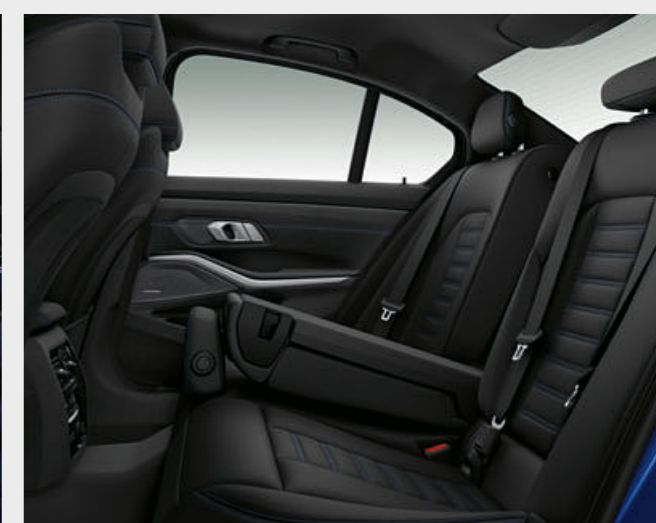

□ The Through-loading system includes rear seat backrests that can be divided in a 40:20:40 ratio for the greatest possible flexibility. For example, two passengers can be seated comfortably in the rear, while long objects such as ski and snowboard bags can be transported at the same time. The two cupholders in the centre armrest are very practical.

¹ Only available in conjunction with additional equipment.
² Part of the Connected Package Professional equipment.

³ The information in the BMW Head-Up Display is not fully visible when viewed through polarised sunglasses. Content shown will depend on the equipment options chosen. Further optional equipment is required to display specific items.

⁴ Supports inductive charging for Qi-compatible mobile phones. Special charging cases are available from Original BMW Accessories for selected smartphones that do not support the Qi standard for inductive charging.
⁵ The WiFi hotspot fulfils all in-vehicle requirements for use of the internet with the maximum LTE standard. Usage is subject to cost.

Some ConnectedDrive Services may differ between countries. Please consult your local BMW partner for more information. The Standard and Optional equipment may differ between countries. Please consult your local BMW partner for more information.

EXTERIOR COLOURS.

Discover even more with the new BMW Brochures app. Available now, for your smartphone and tablet.

■ Standard equipment □ Optional equipment

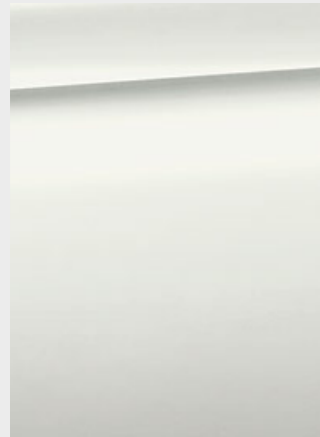

□ Non-metallic 300 Alpine White¹



□ Metallic A96 Mineral White²



□ Metallic A83 Glacier Silver



□ Metallic B39 Mineral Grey²



■ Non-metallic 668 Black

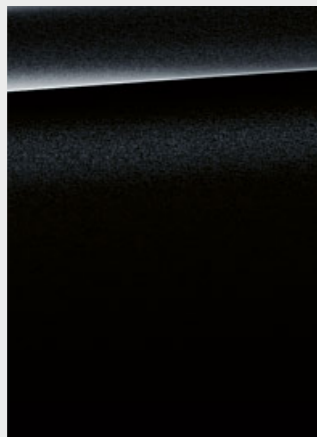

□ Metallic 475 Black Sapphire²



□ Metallic C35 Blue Ridge Mountain³



□ Metallic C10 Mediterranean Blue

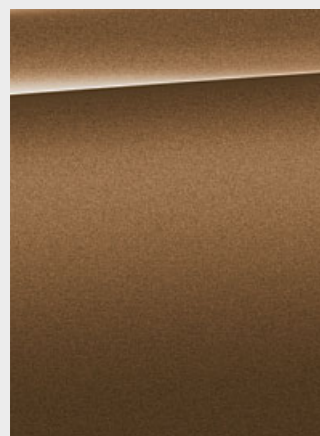

□ Metallic C1Z Vermont Bronze

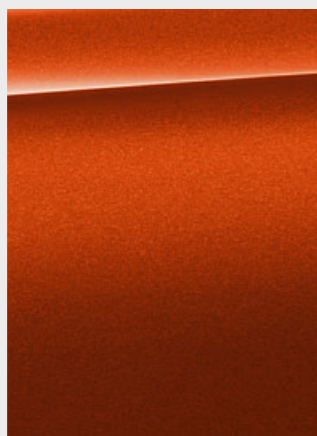

□ Metallic C1X Sunset Orange²

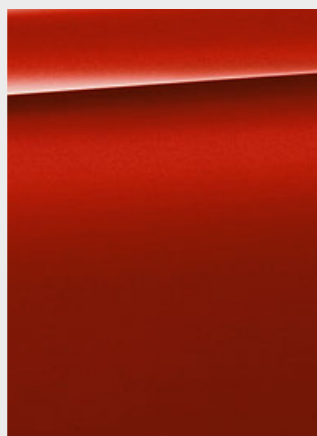

□ Metallic A75 Melbourne Red

BMW INDIVIDUAL

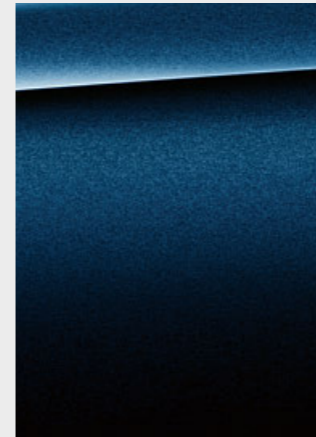

□ BMW Individual C3Z Tanzanite Blue metallic^{2,3}

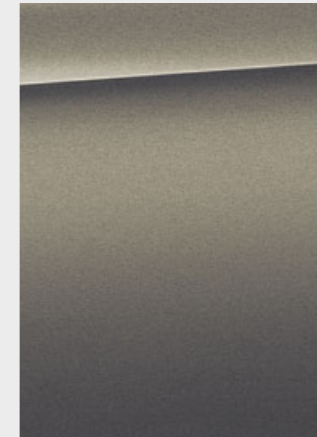

□ BMW Individual C4A Oxide Grey metallic^{2,4}

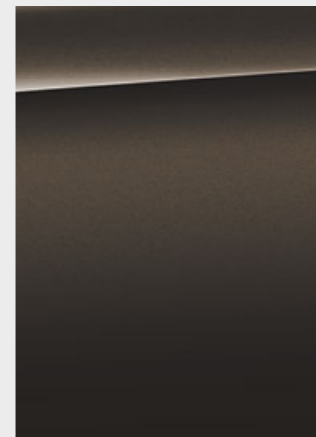

□ BMW Individual C36 Dravite Grey metallic²

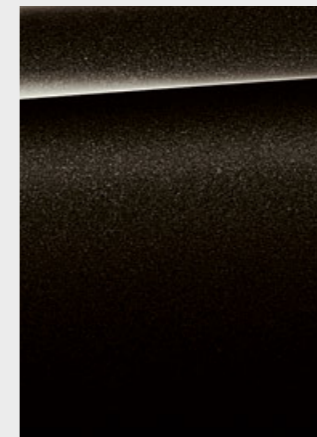

□ BMW Individual C49 Citrine Black metallic^{2,4}



□ BMW Individual 490 special paintwork (e.g. Brilliant White metallic)^{2,4}

M SPORT PACKAGE



□ Metallic C31 Portimao Blue⁵

[Colour samples] These colour samples are intended as an initial guide to the colours and materials available for your BMW. However, experience has shown that printed versions of paint, upholstery and interior trim colours cannot in all cases faithfully reproduce the

appearance of the original colour. Please discuss your preferred colour choices with your BMW partner or in your dealership. There you can also see original samples and be assisted with special requests.

¹ Standard with the M Sport package and M340i xDrive.
² Optionally available with the M Sport package and M340i xDrive.
³ Available from 03/19.
⁴ Available from 07/19.
⁵ Exclusively available with the M Sport package and M340i xDrive.

The Standard and Optional equipment may differ between countries. Please consult your local BMW partner for more information.

Discover even more with the new BMW Brochures app. Available now, for your smartphone and tablet.

■ Standard equipment □ Optional equipment

CLOTH Available with

- Base

Cloth ,Hevelius' EHAT Anthracite, interior colour Black¹



□ Sport Line

Leather 'Vernasca' MANJ Black with decorative stitching, exclusive stitching in Orange^{2,3}

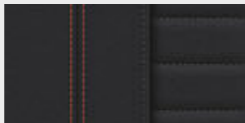

SENSATEC Available with

- Base
- Sport Line

Sensatec KCCY Canberra beige

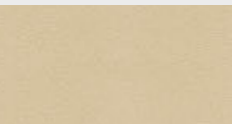

□ M Sport package

Leather 'Vernasca' MANL Black, contrast stitching Blue, interior colour Black³

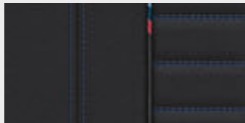

■ Luxury Line

□ Sport Line

□ M Sport package

Leather 'Vernasca' MAOI Oyster with decorative stitching, interior colour Black^{2,3}



- Base
- Sport Line

Sensatec KCFY Canberra Beige, interior colour Black



■ Luxury Line

□ Sport Line

□ M Sport package

Leather 'Vernasca' MAPQ Cognac decor stitching, interior colour Black^{2,3}

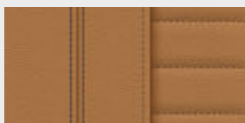

CLOTH-SENSATEC COMBINATION Available with

- Base
- Sport Line

Cloth/Sensatec combination KFSW Black²



INTERIOR TRIM Available with

- Base

Interior trim finishers Quartz Silver matt, grained.



- M Sport package

Alcantara/Sensatec combination KGNL Black, accent Blue²



- Base
- Luxury Line
- Sport Line
- M Sport package

Interior trim finishers in fine-wood trim oak grain open-pored with highlight trim finisher Pearl Chrome.



LEATHER Available with

- Base
- Luxury Line
- Sport Line
- M Sport package

Leather 'Vernasca' MAFO Canberra Beige with decorative stitching, interior colour Black³

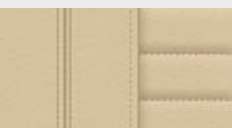

- Base
- Luxury Line
- Sport Line
- M Sport package

Interior trim finishers in fine-wood trim maple open-pored with highlight trim finisher Pearl Chrome.

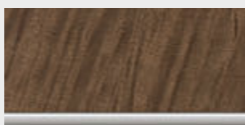

- Base
- Luxury Line
- Sport Line
- M Sport package

Interior trim finishers in fine-wood trim Ash grey-brown high-gloss with highlight trim finisher Pearl Chrome.

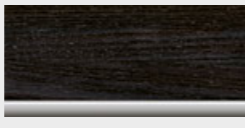

- Base
- Luxury Line
- Sport Line
- M Sport package

Leather 'Vernasca' MAFX Canberra Beige with decorative stitching³



- M Sport package

Interior trim finishers Aluminium Tetragon with highlight trim finisher in Pearl Chrome.



- Base
- Luxury Line
- Sport Line
- M Sport package

Leather 'Vernasca' MAH7 Black decor stitching, interior colour Black³

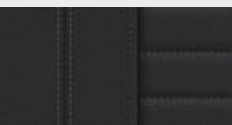

- Base
- Luxury Line
- Sport Line
- M Sport package

Interior trim finishers Aluminium 'Mesheffect' with highlight trim finisher in Pearl Chrome.



- Base
- Luxury Line
- Sport Line
- M Sport package

Leather 'Vernasca' MAMU Mocha with decorative stitching, interior colour Black³

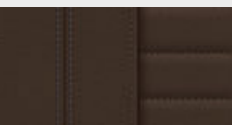

- Base
- Luxury Line
- Sport Line

Interior trim finishers black high-gloss with highlight trim finisher in Pearl Chrome.



BMW INDIVIDUAL UPHOLSTERY COLOURS Available with

- Base
- Luxury Line
- Sport Line
- M Sport package

BMW Individual extended leather trim ,Merino' VAEW Ivory White, interior colour Black^{2,4}



BMW INDIVIDUAL INTERIOR TRIM FINISHERS Available with

- Base
- Luxury Line
- Sport Line
- M Sport package

Interior trim finishers in BMW Individual piano finish Black with highlight trim finisher Pearl Chrome.⁴



- Base
- Luxury Line
- Sport Line
- M Sport package

BMW Individual extended leather trim ,Merino' VAHZ Fiona Red/Black, interior colour Black^{2,4}

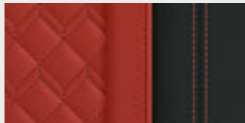

- Base
- Luxury Line
- Sport Line
- M Sport package

BMW Individual fine-wood trim ,Fineline' Black with silver effect open-pored and highlight trim finisher in Pearl Chrome.⁴

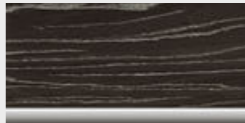

- Base
- Luxury Line
- Sport Line
- M Sport package

BMW Individual extended leather trim ,Merino' VATQ Tartufo, interior colour Black^{2,4}

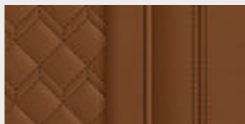

- Base
- Luxury Line
- Sport Line
- M Sport package

BMW Individual interior trim finishers Aluminium fabric high-gloss with highlight trim finisher in Pearl Chrome.⁴



- Base
- Luxury Line
- Sport Line
- M Sport package

BMW Individual extended leather trim ,Merino' ZAFV Fjord Blue/Black, interior colour Black^{2,4}



BMW INDIVIDUAL HEADLINER Available with

- Base
- Luxury Line
- Sport Line
- Sport package

BMW Individual headliner anthracite: Headliner, back shelf and trims on the roof pillars feature Anthracite cloth.

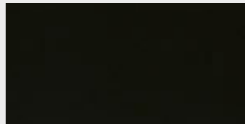

- Base
- Luxury Line
- Sport Line
- M Sport package

BMW Individual extended leather trim ,Merino' ZASW Black, interior colour Black^{2,4}



- Base
- Luxury Line
- Sport Line
- M Sport package

BMW Individual full leather trim ,Merino' VBEW Ivory White, interior colour Black.^{2,4}

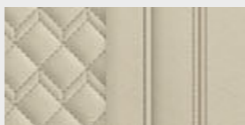

- Base
- Luxury Line
- Sport Line
- M Sport package

BMW Individual full leather trim ,Merino' VBHZ Fiona Red/Black, interior colour Black^{2,4}

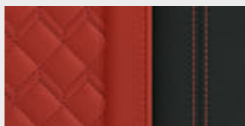

- Base
- Luxury Line
- Sport Line
- M Sport package

BMW Individual full leather trim ,Merino' VBTQ Tartufo, interior colour Black.^{2,4}

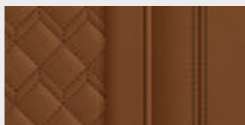

- Base
- Luxury Line
- Sport Line
- M Sport package

BMW Individual full leather trim ,Merino' ZBFV Fjord Blue/Black, interior colour Black^{2,4}

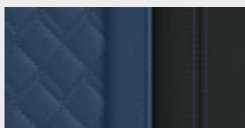

- Base
- Luxury Line
- Sport Line
- M Sport package

BMW Individual full leather trim ,Merino' ZBSW Black, interior colour black^{2,4}

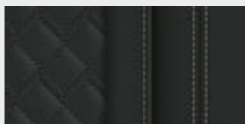

Please note that even normal long- or short-term use can lead to unrecoverable upholstery damage. This can be caused in particular by non-colourfast clothing.

Please note that the interior colour depends on the selected upholstery colour.

¹ Only available in conjunction with standard seats.
² Only available in conjunction with Sport seats.
³ Only available in conjunction with additional equipment.
⁴ Available from 07/19.

The Standard and Optional equipment may differ between countries. Please consult your local BMW partner for more information.

WHEELS AND TYRES.

Discover even more with the new BMW Brochures app. Available now, for your smartphone and tablet.



■ 16" light alloy wheels V-spoke style 774 Reflex Silver, wheel size 6.5J x 16, with 205/60 R16 tyres.¹



□ 16" light alloy wheels turbine styling 773 Bicolour Orbit Grey with runflat tyres, BMW Efficient Dynamics, gloss-lathed, wheel size 6.5J x 16, with 205/60 R16 tyres.²



□ 17" light alloy wheels V-spoke style 778 Reflex Silver, wheel size 7.5J x 17 with 225/50 R17 tyres.³



□ 17" light alloy wheels V-spoke style 775 Bicolour Orbit Grey, gloss-lathed, wheel size 7.5J x 17 with 225/50 R17 tyres.



□ 19" M light alloy wheels Double-spoke style 792 M Bicolour Cerium Grey with mixed tyres and runflat tyres, gloss-lathed, front 8J x 19 with 225/40 R19 tyres, rear 8.5J x 19 with 255/35 R19 tyres.^{4,5}



□ 19" M light alloy wheels Double-spoke style 791 M Jet Black uni with mixed tyres and runflat tyres, gloss-lathed, front 8J x 19 with 225/40 R19 tyres, rear 8.5J x 19 with 255/35 R19 tyres.⁶



□ 19" BMW Individual light alloy wheels Double-spoke style 793 in Bicolour Orbit Grey with mixed tyres and runflat tyres, gloss-lathed, front 8J x 19 with 225/40 R19 tyres, rear 8.5J x 19 with 255/35 R19 tyres.

ORIGINAL BMW ACCESSORIES.

■ Standard equipment □ Optional equipment ○ Accessories



○ The modern BMW roof box in black with titanium silver side panels has a storage capacity of 420 litres and is compatible with all BMW roof rack systems. Due to the fact that it can be opened from both sides and has triple central locking on each side it is convenient to load and lock for theft protection.



○ BMW Advanced Car Eye 2.0 is a highly sensitive full HD camera, which automatically records what is going on around the vehicle during disturbances and extraordinary movement. The Connectivity Module app enables additional innovative functions such as live streaming, GPS vehicle location tracking, and Cloud storage of all recordings.

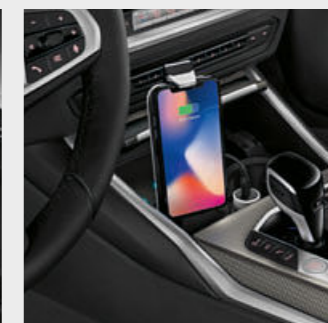

○ Thanks to the BMW wireless charging station universal, the smartphone can be charged comfortably without a cable – even outside the vehicle.



○ Precisely fitted protection against moisture and dirt in the front footwell. Featuring a black design with a stainless steel inlay, they perfectly complement the interior.



○ The high-quality 20" M Performance forged wheels Cross-spoke style 794 M are designed in Bicolor Jet Black, gloss-lathed and feature the colour M Logo. TPMS summer complete wheel set with run-flat tyres, wheel size 8J x 20 with tyre size 225/35 R20 90YXL RSC at the front and 8.5J x 20 with tyre size 255/30 R20 92YXL RSC at the rear.



○ High-quality 20" M Performance forged wheels Y-Spoke 795 M in Bicolor Ferric Grey matt, gloss-milled. TPMS summer complete wheel set with run-flat tyres.



○ Anti-slip, water-resistant mat for protecting the luggage compartment from dirt and moisture. In black with stainless steel inlay matching the interior.

¹ Standard for 320i, 318d and 320d.
² Only available for 320i, 318d and 320d.
³ Standard for the 330i, 320d xDrive, 330d and 330e.

⁴ Available from 07/19.
⁵ Exclusively available for M340i xDrive.
⁶ Only available in conjunction with M Sport package or for M340i xDrive.

Discover the all-round innovative solutions on offer in many categories: exterior, interior, communication & information and transport & luggage compartment. Your BMW partner will be happy to advise you and provide you with a special catalogue detailing the entire range of Original BMW Accessories. For further information, please visit www.bmw.com/accessories

The Standard and Optional equipment may differ between countries. Please consult your local BMW partner for more information.

BMW 3 Series Saloon	BMW 320i ^{***,7}	BMW 330i	BMW M340i xDrive ^{*,8}	BMW 318d ^{***,7}	BMW 320d BMW 320d xDrive	BMW 330d ^{***,7}	BMW 330e ^{*,8}
---------------------	---------------------------	----------	---------------------------------	---------------------------	--------------------------	---------------------------	-------------------------

Weight								
Unladen weight EU ¹	kg	[1525] ¹⁰	[1545]	–	1520 [1530] ¹⁰	1525 [1530]	[1665] ¹⁰	– ¹⁰
Unladen weight EU (xDrive) ¹	kg	–	–	– ¹⁰	–	[1615]	–	– ¹⁰
Maximum permissible weight	kg	– ¹⁰	[2060]	–	– ¹⁰	2075 [2085]	– ¹⁰	– ¹⁰
Max. permissible weight (xDrive)	kg	–	–	– ¹⁰	–	[2170]	–	– ¹⁰
Permitted load	kg	– ¹⁰	[580]	–	– ¹⁰	610 [610]	– ¹⁰	– ¹⁰
Permitted load (xDrive)	kg	–	–	– ¹⁰	–	[600]	–	– ¹⁰
Permitted trailer load, unbraked ²	kg	– ¹⁰	[750]	–	– ¹⁰	745 [750]	– ¹⁰	– ¹⁰
Permitted trailer load, unbraked (xDrive) ²	kg	–	–	– ¹⁰	–	[750]	–	–
Permitted trailer load, braked, max. 12% gradient/max. 8% gradient ²	kg	– ¹⁰	[1600/1600]	–	– ¹⁰	1600/1600 [1600/1600]	– ¹⁰	– ¹⁰
Permitted trailer load, braked, max. 12% gradient/max. 8% gradient (xDrive) ²	kg	–	–	– ¹⁰	– ¹⁰	[1600/1600]	– ¹⁰	– ¹⁰
Luggage compartment capacity	l	– ¹⁰	480	– ¹⁰	– ¹⁰	480	– ¹⁰	– ¹⁰

BMW TwinPower Turbo engines								
Cylinders/valves		4/4	4/4	6/6 ¹⁰	4/4 ¹⁰	4/4	4/4 ¹⁰	4/4 ¹⁰
Capacity	cc	1998	1998	– ¹⁰	– ¹⁰	1995	– ¹⁰	– ¹⁰
Rated output/rated engine speed	kW (hp)/rpm	135 (184) ^{–10}	190 (258)/5000–6500	275 (374)/5500–6500 ¹⁰	110 (150) ^{–10}	140 (190)/4000	195 (265) ^{–10}	135 (184) ^{–10}
Max. torque/engine speed	Nm/rpm	300 ^{–10}	400/1550–4400	500/1850–5000 ¹⁰	320 ^{–10}	400/1750–2500	580 ^{–10}	300 ^{–10}

eDrive motor								
Top performance	kW (hp)	–	–	–	–	–	–	83 (113) ¹⁰
Max. torque	Nm	–	–	–	–	–	–	265 ¹⁰
System output	kW (hp)	–	–	–	–	–	–	185 (252) ¹⁰
System torque	Nm	–	–	–	–	–	–	420 ¹⁰

Lithium-ion high-voltage battery								
Battery type/net battery capacity	kWh	–	–	–	–	–	–	– ¹⁰
Electric range/Maximum total range, combined ³	km	–	–	–	–	–	–	up to 60 ¹⁰
Charging time (0–80%)(0–100%)	h	–	–	–	–	–	–	– ¹⁰

Power transmission								
Type of drive		Rear-wheel	Rear-wheel	All-wheel	Rear-wheel	Rear-wheel/all-wheel	Rear-wheel	Rear-wheel
Standard transmission		Steptronic	Steptronic	–	Manual	Manual	Steptronic	Steptronic
Standard transmission (xDrive)		–	–	Steptronic	–	Steptronic	–	–

Performance								
Top speed	km/h	[238] ¹⁰	[250] ⁴	–	226 [222] ¹⁰	240 [240]	[250] ^{4,10}	[230] ¹⁰
Top speed (xDrive)	km/h	–	–	[250] ^{4,10}	–	[233]	–	–
Top electric speed	km/h	–	–	–	–	–	–	[140] ¹⁰
Acceleration 0–100 km/h	s	[7.2] ¹⁰	[5.8]	–	8.5 [8.4] ¹⁰	7.1 [6.8]	[5.5] ¹⁰	[6.0] ¹⁰
Acceleration (xDrive) 0–100 km/h	s	–	–	[4.4] ¹⁰	–	[6.9]	–	–

Fuel consumption ^{4,5,6}								
Urban	l/100 km	– ¹⁰	[7.2–7.7]	–	– ¹⁰	5.4–5.7 [4.9–5.1]	– ¹⁰	– ¹⁰
Urban (xDrive)	l/100 km	–	–	– ¹⁰	–	[5.2–5.5]	–	–
Extra-urban	l/100 km	– ¹⁰	[5.0–5.2]	–	– ¹⁰	3.8–4.1 [3.8–4.1]	– ¹⁰	– ¹⁰
Extra-urban (xDrive)	l/100 km	–	–	– ¹⁰	–	[4.1–4.4]	–	–
Combined	l/100 km	[5.7–6.0] ¹⁰	[5.8–6.1]	–	4.2–4.5 [4.1–4.4] ¹⁰	4.4–4.7 [4.2–4.5]	[4.8–5.2] ¹⁰	from 1.7 ¹⁰
Combined (xDrive)	l/100 km	–	–	[7.5] ¹⁰	–	[4.5–4.8]	–	–
Consumption range, combined	kWh/100 km	–	–	–	–	–	–	– ¹⁰
Exhaust emissions standard (type-certified)		EU6d-temp	EU6d-temp	EU6d-temp	EU6d-temp	EU6d-temp	EU6d-temp	EU6d-temp
CO ₂ emissions, combined	g/km	[129–137] ¹⁰	[132–139]	–	112–120 [108–116] ¹⁰	115–122 [110–117]	[128–136] ¹⁰	from 39 ^{10,11}
CO ₂ emissions, combined (xDrive)	g/km	–	–	[172] ¹⁰	–	[118–125]	–	–
Tank capacity, approx.	l	– ¹⁰	59	– ¹⁰	– ¹⁰	40	– ¹⁰	– ¹⁰

Wheels/tyres								
Tyre dimensions		205/60 R16 96W ¹⁰	225/50 R17 98Y	225/45 R18 95Y 225/40 R18 99Y ¹⁰	205/60 R16 96W ¹⁰	205/60 R16 96W ⁹	225/50 R17 98Y ¹⁰	225/50 R17 98Y ¹⁰
Wheel dimensions		6.5 J x 16 ¹⁰	7.5 J x 17	7.58.5 J x 18 ¹⁰	6.5 J x 16 ¹⁰	6.5 J x 16 ⁹	7.5 J x 17 ¹⁰	7.5 J x 17 ¹⁰
Material		Light alloy	Light alloy	Light alloy	Light alloy	Light alloy	Light alloy	Light alloy

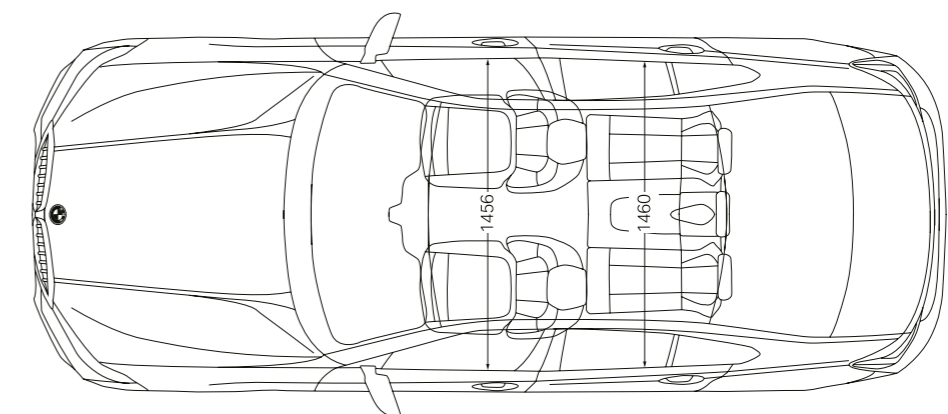
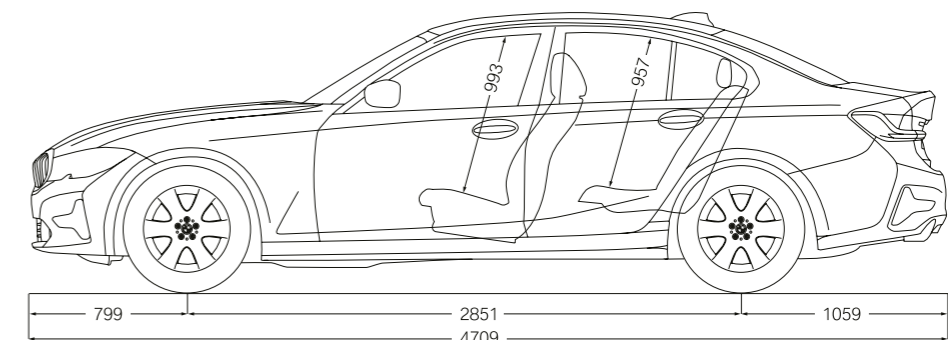
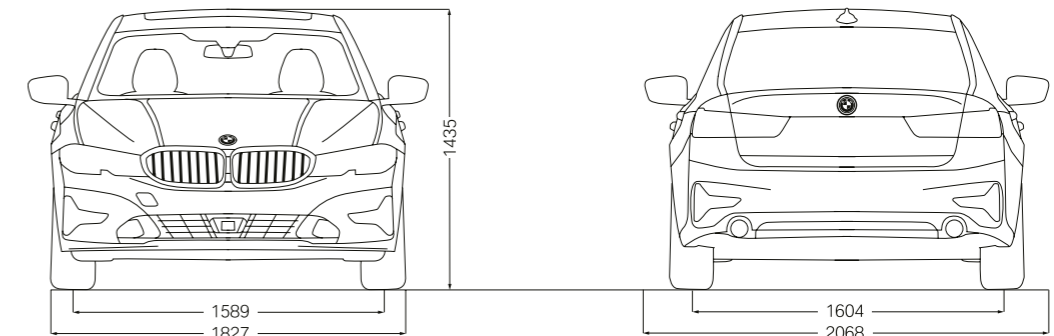

Figures in [] are for vehicles with Steptronic transmission.

¹ The EC unladen weight refers to a vehicle with standard equipment and does not include any optional extras. The unladen weight includes a 90% full tank and a driver weight of 75 kg. Optional equipment may affect the weight of the vehicle, the payload and the top speed if the selected equipment has an impact on the vehicle's aerodynamics.

² The actual total weight of the trailer must not exceed the maximum permitted trailer load, taking into account the maximum tow bar download.

³ Range depends on the equipment and various factors. In particular: personal driving style, route characteristics, exterior temperature, heating/air conditioning, pre-conditioning and the chosen equipment.

⁴ Electronically limited.

⁵ Performance data of petrol engines apply to vehicles using RON 98 fuel. Fuel consumption data apply to vehicles using reference fuels in accordance with EU Regulation 2007/15. Unleaded RON 91 and higher with a maximum ethanol content of 10% (E10) may also be used. BMW recommends RON 95 super unleaded petrol.

⁶ The data for fuel consumption, CO₂ emissions and energy consumption are determined in accordance with the measurements processes as defined by European Regulation (EU) 2007/15 in the applicable version. Data refer to a vehicle with base-level equipment in Germany, and the ranges account for differences according to the selected wheel and tyre size and the optional equipment and may change during the configuration process. Figures have been determined on the basis of the new WLTP test cycle and have been converted back into NEDC figures for comparability. [For vehicles indicated with **, values other than those specified here may apply for the assessment of taxes and other vehicle-related charges that are (also) based on CO₂ emissions].

⁷ Expected to be available from 03/2019.

⁸ Expected to be available from 07/2019.

⁹ Tyre size for 320d xDrive: 225/50 R17 98Y; wheel size for 320d xDrive: 7.5 J x 17.

¹⁰ Provisional figures; any missing figures were unavailable at the time of publication.

BMW 330i SALOON WITH M SPORT PACKAGE:

BMW TwinPower Turbo 4-cylinder petrol engine, 190kW (258hp), 19" M light alloy wheels Double-spoke style 791 M Bicolour, exterior colour in Portimao Blue metallic, BMW Laserlight, Instrument panel in Sensatec, Sport seats in leather Vernasca Black with contrast stitching in Blue, interior trim finishers in Aluminium Tetragon.

The models illustrated in this brochure show the equipment and configuration options (standard and optional) for vehicles produced by BMW AG for the German market. Alterations in standard and optional equipment and the configurations available for the different models, as described in this brochure, may occur after 09/03/2018, the date when this brochure went to press, or according to the specific requirements of other markets. Your local BMW Partner is available to provide further details. Subject to change in design and equipment.

© BMW AG, Munich, Germany. Not to be reproduced wholly or in part without prior written permission of BMW AG, Munich.

411 003 380 20 2 2018 BC. Printed in Germany 2018.

